



Hong Kong & Kowloon Timber Merchants Association

Proposed Temporary Rural Workshop
(Timber Yard and Sawmill) in Various Lots in
D.D. 86, D.D. 90 and Adjoining Government
Land, Lin Ma Hang Road, San Uk Ling, Ma
Kam To

Drainage Impact Assessment

Project Profile Report

March 2024

Drainage Impact Assessment Report prepared by:

A handwritten signature in blue ink, appearing to read 'Colin C Moreby'.

Ir Colin C MOREBY BEng, CEng, MICE, MHKIE, RPE(Civil)

Contents

1	Introduction	1
1.1	Background	1
1.2	Information Available for the Study	1
2	Project Outline	2
2.1	Project Title	2
2.2	Proponent	2
2.3	Contact Person	2
2.4	Nature and Description of the Project	2
2.5	Planning Application and Lease Modification	3
2.6	Location and Zoning	3
3	Planning and Implementation Programme	3
3.1	Planning and Implementation	3
3.2	Project Timetable	3
3.3	Interface with Other Projects	3
4	Existing Drainage	3
4.1	Existing Drainage Routes and Conditions	3
5	Drainage Impact Assessment	5
5.1	Drainage Impact Assessment	5
5.2	Drainage Impact	6
6	Conclusions	9

APPENDICES

Appendix A

Master Layout Plan

Appendix B

As-constructed Drainage

Appendix C

Site Photographs

Appendix D

Runoff Calculations

Appendix E

Hydrograph and Storage Calculations

Appendix F

Stream Hydraulics

Appendix G

Prefabricated Drainage Units

Appendix H

Overflow Weir Calculations

Appendix I

Drainage Schedule

Appendix J

Figures

Figure 1 - Site Location Plan

Figure 2 - Existing Local Drainage Arrangements

Figure 3 - Overall Catchment Area (Eastern Site)

Figure 4 - Upstream Catchment Area (Western Site)

Figure 5 - Overflow Weir Arrangements

Figure 6 - Site Catchments & Drainage Plan (Western Site)

1 Introduction

1.1 Background

- 1.1.1 This Drainage Impact Assessment (DIA) has been prepared to discharge Town Planning Approval Condition (c) for the Site, in accordance with Town Planning Board (TPB) letter ref. TPB/A/NE-MKT/17 dated 14 May 2021.
- 1.1.2 The Site is to be developed to provide simple workshop facilities for a period of 3 years.
- 1.1.3 This Report assesses the drainage impacts in the vicinity of the Site as a result of the proposed development, with discussion of proposed mitigation measures.
- 1.1.4 This Project Profile Report has been prepared in accordance with the requirements of the DIA process for private sector projects set out under Drainage Services Department's (DSD's) Technical Advice Note No. 1 (Appendix I).
- 1.1.5 A DIA for the Project was previously accepted without comment in May 2022 and the eastern portion of the overall Site has been substantially completed in accordance with that DIA. However, due to changes to the Project Programme and the Site Boundary in the western portion of the Site, the DIA has been updated. **It is noted that the essential principles of this updated DIA are the same as the previously accepted DIA.**

1.2 Information Available for the Study

- 1.2.1 Reference has been made to Drainage Services Departments DSD's Stormwater Drainage Manual (SDM), 5th Edition, and public drainage information presented on Land's Department's GeoInfo Map website.
- 1.2.2 A local topographic survey has also been carried out for the Project, although the survey coverage is not extensive beyond the Site Boundaries.

2 Project Outline

2.1 Project Title

2.1.1 The project title is “Proposed Rural Workshop (Timber Yard and Sawmill) for a period of 3 years in “Agriculture” Zone, Lot 129 (Part) in D.D. 86, Lots 607, 608, 609, 610 S.B RP (Part), 613 (Part), 627 (Part), 632 S.A RP, 633 S.A RP (Part), 635 S.A, 635 S.B, 635 S.C, 635 S.D, 637, 638 (Part) and 642 S.A RP (Part) in D.D. 90 and Adjoining Government Land, Lin Ma Hang Road, San Uk Ling, Ma Kam To”. The location of the Site is shown on **Figure 1**.

2.2 Proponent

2.2.1 The proponent of the project is Hong Kong and Kowloon Timber Merchants Association.

2.3 Contact Person

2.3.1 For issues relating to this DIA Study, please contact Ir Colin Moreby of AIM Group Limited at 2572 6533.

2.4 Nature and Description of the Project

2.4.1 The proposed development consists of various covered workshop buildings, with access roads and parking/turning areas. There will also be some buffer planting areas. The Master Layout Plan for the proposed development is included in **Appendix A**. The TPB Approval is for a period of 3 years, so all facilities will be generally temporary in nature. As noted above, drainage works at the Site have been substantially completed in accordance with the previous DIA (see As-constructed details in **Appendix B**). It should be noted that some of the As-constructed details in Site C are likely to be modified as part of later expansion works.

2.4.2 The overall Application Site is split into two portions, with (adjoining) Sites A and B located to the south of Lin Ma Hang Road and Sites C, D and E to the north of the road. Sites A and B cover a combined area of approximately 9,088m², while Sites C, D and E cover an area of approximately 11,493m².

2.5 Planning Application and Lease Modification

2.5.1 This DIA – Project Profile has been prepared to discharge Planning Condition (c) of the TPB Approval Letter.

2.5.2 No Lease Modification is required for the proposed Project.

2.6 Location and Zoning

2.6.1 The Application Site is located to the south and north of Lin Ma Hang Road, a short distance to the northeast of San Uk Ling.

2.6.2 The Site is zoned as “Agriculture”.

3 Planning and Implementation Programme

3.1 Planning and Implementation

3.1.1 The proposed redevelopment will be planned and implemented under the supervision of appropriately qualified and experienced professionals. The construction of any works for the proposed redevelopment will be carried out by a suitable Contractor.

3.2 Project Timetable

3.2.1 The Redevelopment is expected to be complete by mid-2024.

3.3 Interface with Other Projects

3.3.1 There is no foreseeable direct interaction with other development projects in the area, which should be considered at this time.

4 Existing Drainage

4.1 Existing Drainage Routes and Conditions

4.1.1 The two main Site areas are both partially filled and paved, with the land falling generally from northeast to southwest across the Sites. The existing land in Site E generally falls from northwest to southeast. There were no existing formal drainage systems at the Sites, apart from small

simple unlined open channels, with runoff mostly passing overland to adjacent areas and nearby Streamcourses to the south and east of the Sites. There is another existing open channel to the north of Sites A & B, which cuts off runoff from areas to the north of the Sites. This channel passes under Lin Ma Hang Road and continues towards the north along the eastern boundary of Site E. The existing local drainage regimes are indicated on **Figure 2**.

- 4.1.2 As mentioned above, Site drainage facilities in Sites A and B have been constructed in accordance with the previous (2022) DIA.
- 4.1.3 To the south of Sites A & B there is an existing natural open channel (streamcourse) running generally from southeast to northwest before discharging to the Shenzhen River close to the Man Kam To Border Crossing. In the vicinity of the Site, the streamcourse is mostly unlined, but fairly straight and with the sides formed by the access road to Muk Wu Village and the supporting wall at the Site Boundary (i.e. the walls are concrete, but the base is soil/silt). It serves an upstream catchment, as shown on **Figure 3**.
- 4.1.4 The existing Site contains some buildings and some areas of paving and hardstanding (compacted broken asphalt). There are also some flat areas of vegetation. Photographs of the existing Site are included in **Appendix C** (N.B. it should be noted that some parts of the existing Site are currently overgrown and access is limited).
- 4.1.5 There are no flooding blackspots in the vicinity of the Site and informal discussions with local residents and landowners suggest that there is no history of flooding in the area.
- 4.1.6 There are no known Ecologically Important Streams/Rivers in the area.

5 Drainage Impact Assessment

5.1 Drainage Impact Assessment

General

- 5.1.1 The proposed development at the Site will involve paving of the ground surface and the construction of temporary workshop structures, with most of the Site being roofed over. As such, there will be an increase in paving, with a resultant increase in runoff. These increases have been quantified, with mitigation measures proposed to offset the increases, as discussed below.
- 5.1.2 The Site Areas will be provided with peripheral channels throughout, to collect any runoff from outside the Site (e.g. from Lot No. 630RP) and to prevent runoff from the Site towards adjacent areas. As such, the adjacent areas will not be adversely affected by the proposed development.

Assessment Criteria

- 5.1.3 As the catchment areas are all fairly small, the Rational Method (as set out in Section 7.5.2 of the SDM) has been used for the calculation of runoff.
- 5.1.4 The existing Site contains some buildings and temporary structures, as well as some fully paved (concrete) areas and a runoff coefficient, C, of 0.95 has been adopted for these areas. There are also areas of (compacted broken asphalt) hardstanding for which a runoff coefficient of 0.75 has been adopted. A runoff coefficient of 0.20 has been adopted for the remaining vegetated/farmland areas.
- 5.1.5 The proposed development will introduce additional paving and covered workshop structures (C = 1.00 has been adopted for these). There will also be some flat buffer landscaping (C = 0.20).
- 5.1.6 The overall upstream catchments mostly comprise steep vegetated hillsides with a runoff coefficient of 0.35 assumed. The amount of paving is hard to determine accurately, so an area equivalent to 2.5% of the overall catchment area has been assumed (C = 0.90), except where actual measurement (from maps) is feasible.
- 5.1.7 The 1 in 10-year scenario has been considered, as runoff from the Site will only affect minor local village areas and nearby (largely unused)

farmland. Furthermore, the approved usage at the Site is only for a period of 3 years, so a higher return period is not considered justified.

- 5.1.8 Allowances for increased rainfall intensity up to mid-21st Century and beyond have not been considered, as the TPB Approval is only for a period of 3 years.
- 5.1.9 The proposed mitigation measures involve the provision of temporary storage and it is therefore necessary to consider runoff hydrographs. Runoff hydrographs have been developed for each Site Area based on the 1 in 10-year design rainfall profile for North District set out in Table 5d of the SDM, with assessments of 10-minute, 30-minute and 1-hour storm durations. A 90-minute storm has also been considered for the Western Site (Sites C, D and E) for reference.

5.2 Drainage Impact

- 5.2.1 The existing and future runoff flows from the overall Sites and overall catchments are presented in **Appendix D**. As the two main portions of the overall Application Site are physically independent, the drainage impacts will be discussed separately.

Eastern Portion (Sites A and B)

- 5.2.2 The discharge from Sites A & B will increase from approximately 0.199m³/s to 0.429m³/s as a result of the proposed development. However, in terms of the overall catchment served by the main streamcourse, the overall runoff from the Site will increase from 0.290m³/s to 0.326m³/s (partly as a result of diversion of the runoff from Sites C and D, as discussed below), an increase of only 0.5% of the overall catchment runoff. Such an increase is well within the accuracy of runoff calculations and is therefore insignificant.
- 5.2.3 Although the overall increased runoff will not significantly change the flow from the overall catchment, there will be more significant increases at the local level. Given the absence of flooding records in the area, it can be reasonably assumed that the existing peak flows can be accommodated within the existing drainage system(s) and it is therefore proposed to provide storage for flows in excess of the existing peak runoff. The storage volumes required are presented in **Appendix E**, including runoff hydrographs for each of the storm durations for each portion of the Site. The required storage volumes for the 30-minute and 1-hour storm durations are the same and have been adopted as the minimum storage volumes to be provided, i.e. 147.3m³ for Sites A & B. However, as the storage volumes will be provided by multiple standard-sized

prefabricated tanks, the actual volumes to be provided will be greater than the minimum volumes required. For Sites A & B, the actual volume will be $3 \times 55\text{m}^3 = 165\text{m}^3$.

- 5.2.4 The south-eastern corner of the Site is close to the existing streamcourse and, to avoid any future conflict, all main building structures in this area will be set back a minimum of 3m from the bank of the stream.
- 5.2.5 The construction works in the eastern portion of the Site, including the Site drainage facilities, have been substantially completed.

Western Portion (Sites C, D and E)

- 5.2.6 Following discussions with Highways Department, the option of discharging from the Site to the road drainage in Lin Ma Hang Road and hence to the main streamcourse to the south of the Site is considered not feasible. It will therefore be necessary to discharge all runoff from the western portion of the Site (Sites C, D and E) to the existing streamcourse to the east of the Site, running partially below the recently constructed access road to Muk Wu Village. The upstream catchment area for this stream is shown on **Figure 4**.
- 5.2.7 As a result of the diversion of flows from Sites C and D towards the east and increased paving at the Site, the theoretical discharge from the Site towards the east would increase from $0.074\text{m}^3/\text{s}$ to $0.591\text{m}^3/\text{s}$. As for the eastern portion of the Site, it is proposed to provide storage facilities (buried tanks) to temporarily store excess runoff from the Site, to reduce the peak discharge. The existing eastern streamcourse comprises a significant channel (approximately $1\text{m} \times 1\text{m}$) and capacity calculations (see **Appendix F**) indicate that it could accommodate some increased runoff from the Site. However, due to limited physical survey data and to keep the assessment conservative, it is proposed to limit the future runoff from the Site to a nominal $0.25\text{m}^3/\text{s}$. This figure has been used for the hydrographs for the Western Site in **Appendix E**, and the resultant temporary storage volume of just under 250m^3 . It is noted that the required storage volumes for the 60-minute and 90-minute rainfall events are the same, so this has been adopted for this DIA and no further assessment of longer-duration rainfall is required. The storage will be provided as $4 \times 75\text{m}^3$ standard tanks.
- 5.2.8 At the Site boundary, the stream comprises a substantial well-defined channel, with the western side formed by concrete blocks supporting the Site boundary and the eastern side formed by the structure of the access road (see Appendix C). The crossing beneath Lin Ma Hang Road appears to be quite restricted (see Appendix C) and this supports the concept that the channel can accept additional flows from the Site.

General Issues

- 5.2.9 It is proposed to provide the storage in the form of buried plastic tanks (as indicated in **Appendix G** – actual dimensions to be confirmed), with small pumps also provided to gradually empty the tanks over an extended period (say, an hour or two). Inflow to the tanks would be controlled by simple overflow weirs (as illustrated in **Figure 5** and with calculations included in **Appendix H**).
- 5.2.10 Peripheral channels and on-Site underground pipe drainage systems to suit the MLP will be provided to collect all runoff from the Site and all runoff entering the Site from other adjacent catchments. It is proposed that prefabricated units (as shown in **Appendix F**) will be used to simplify construction and maintain standards. The Site Catchment Areas & Drainage Plan for the western Site is included as **Figure 6**. A Drainage Schedule showing the required and proposed gradients of the peripheral channels and internal pipes is included in **Appendix I**.
- 5.2.11 Sites A & B will discharge directly (via a sand trap) into the main Streamcourse to the south of the Site (as under the existing scenario).
- 5.2.12 Silt/sand traps and Terminal Manholes (if appropriate) will be provided at all discharge points.
- 5.2.13 The Project Proponent will be responsible for the construction and maintenance of all drainage facilities for the Project.

6 Conclusions

- 6.1.1 There will be increases in the volume of runoff from the Site as a result of the Proposed Redevelopment.
- 6.1.2 Runoff from Sites A and B will discharge to an existing streamcourse to the south of the Site. Runoff from Sites C, D and E will discharge to an existing channel to the east of the Site.
- 6.1.3 Peripheral channels, etc. will be provided to collect any flow entering the Site from external areas and to prevent discharge from the Site to adjacent areas. Underground pipes will be provided to collect internal runoff from most Site areas.
- 6.1.4 Temporary storage of runoff will be provided for flows in excess of the acceptable peak flows. The actual storage to be provided will be greater than the minimum volumes calculated.
- 6.1.5 Construction and maintenance of all new drainage facilities will be undertaken by the Project Proponent.
- 6.1.6 There will be no unacceptable increases to the risks of flooding at the Site or in surrounding areas and no unacceptable adverse drainage impacts.

Appendix A

Master Layout Plan

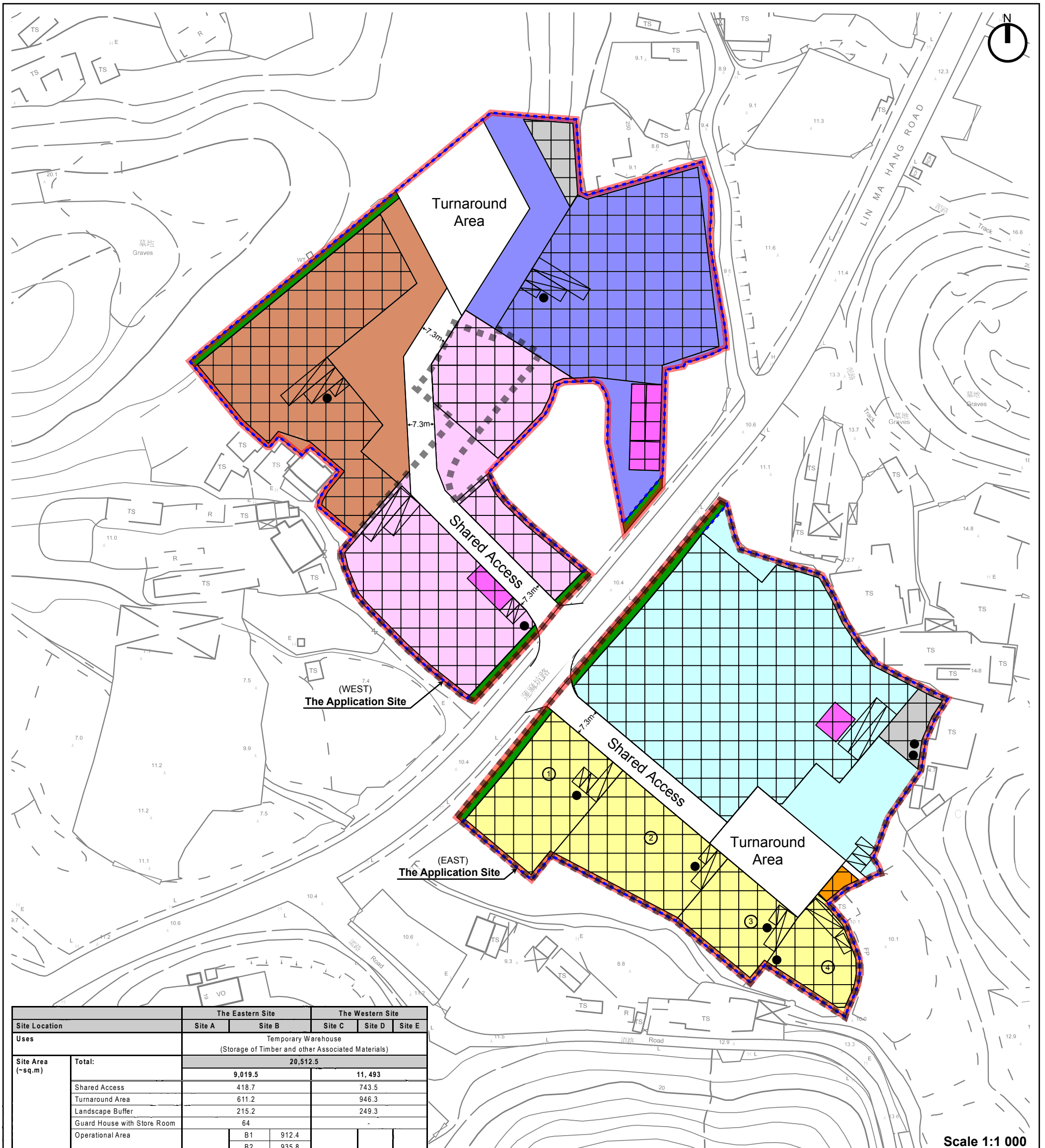

		The Eastern Site		The Western Site		
Site Location		Site A	Site B	Site C	Site D	Site E
Uses		Temporary Warehouse (Storage of Timber and other Associated Materials)				
Site Area (~sq.m)	Total:	20,512.5				
	Shared Access	418.7			743.5	
	Turnaround Area	611.2			946.3	
	Landscape Buffer	215.2			249.3	
	Guard House with Store Room	64				
	Operational Area	4,856.3	B1: 912.4 B2: 935.8 B3: 546.8 B4: 459.1 Subtotal: 2,854.1	2,941.3	2,898.7	3,713.9
Site Coverage (~sq.m)	Total:	13,922.9				
		6,728.8		7,194.1		
Gross Floor Area (~sq.m)	Total:	6,824.8		7,438.1		
	Structure for warehouse, parking, loading/ unloading (1 storey, 12m in height)	3,780.8 (excluding office area)	2,690.5	2,479.5 (excluding office area)	1,997.2	2,303.7
	Shed (1 storey, 8m in height)	161.5	-	-	-	169.6
	Ancillary Office (2 storeys, 5m in height)	112	-	122	-	366
	Guard House with Store Room (2 storey, 6m in height)	80				
Internal Transport Facilities	private car parking spaces (2.5m x 5m)	3	5	2	1	1
	loading/unloading bays for HGV or MGW (3.5 x 11m)	-	4	1	1	1
	loading/unloading bays for container vehicle or HGV (3.5 x 16m)	2	-	1	1	1

Scale 1:1 000

Legend			
	Application Site Boundary		Fence Wall
	Planning Approval Boundary		Site A
	Structure for workshop, storage, parking, loading/ unloading (approx. 12m in height)		Site B
	Shed (approx. 8m in height)		Site C
	Office (approx. 5m in height)		Site D
	Location of Temporary Portable Toilets		Site E
	Guard House		Parking Space for Private Cars (5m x 2.5m)
	Reserved 2m Landscape Buffer		Loading/Unloading Space for HGV/MGW (11m x 3.5m)
			Loading/Unloading Space for Container Vehicles (16m x 3.5m)

Site A: Million Loy Development Ltd.
 Site B1: Truefaith Enterprises Ltd.
 Site B2: Fai Kee Timber Co. Ltd.
 Site B3: Tak Kee Timber Company
 Site B4: Wong Chu Kee Timber
 Site C: Polyribe Timber Ltd.
 Site D: Serawak (K.T.) Company Ltd.
 Site E: Ronca Exhibition Ltd.







Plan 1: Master Layout Plan

Appendix B

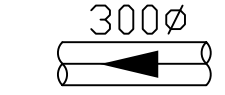
As-constructed Drainage

- Notes :
1. Co-ordinates are relative to Hong Kong Metric Grid (1980)
 2. All Levels are in Metres relative to Principal Datum (P.D.)
 3. Elevation of kerb are referred to bottom of kerb
 4. Dimensions are in Metres unless otherwise shown

- Legends:
-  As-built Drain Pipe
 -  As-built U-Channel
 -  As-built Invert Level
 -  As-built Catchpit
 -  As-built Ground Level

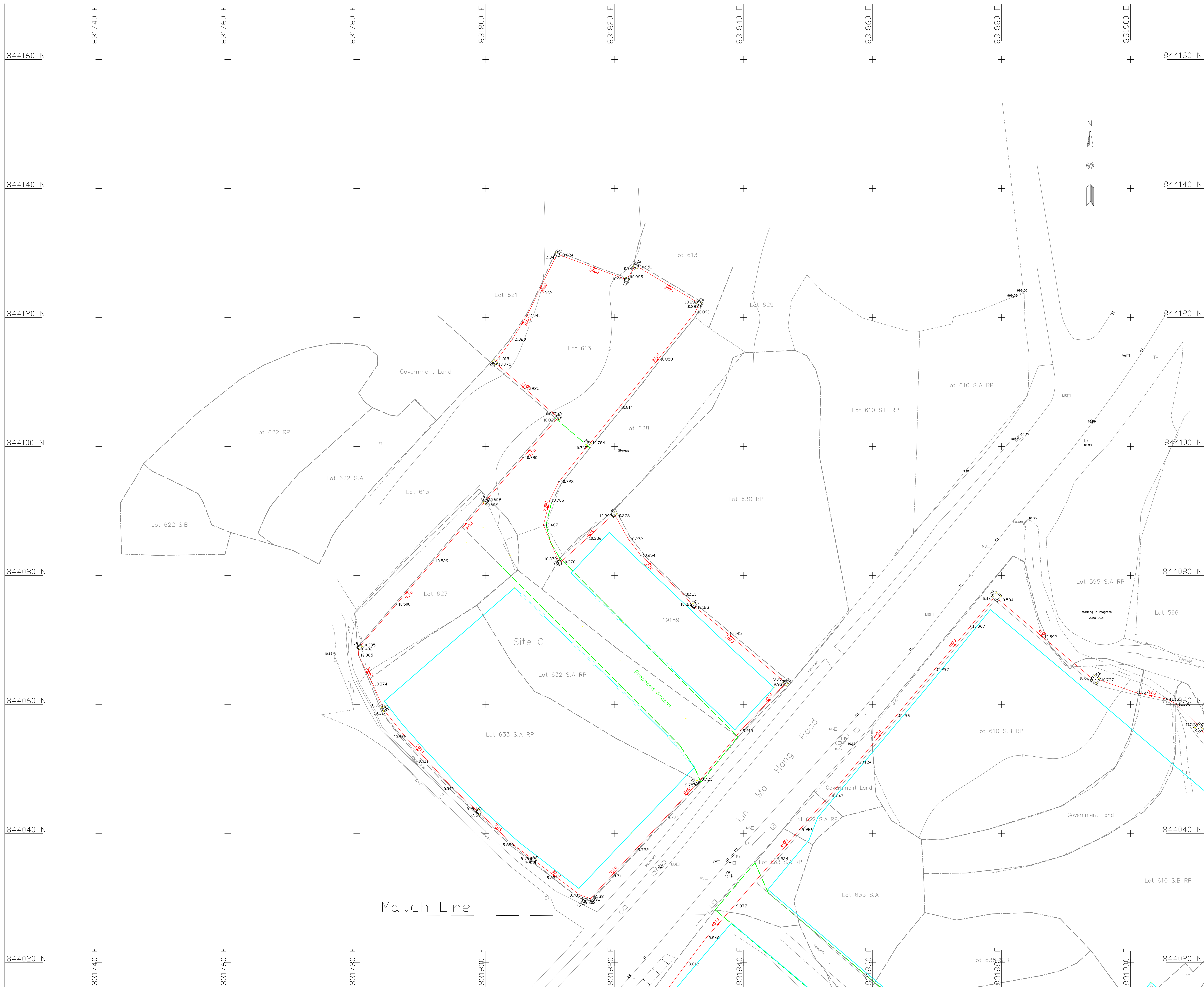
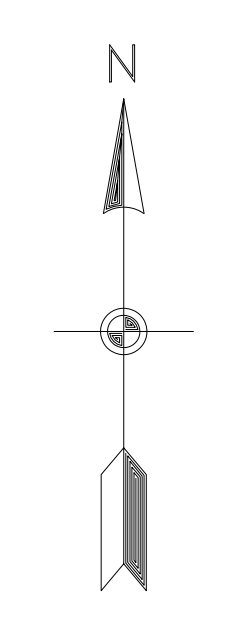

DRAWING TITLE :
 As-Built Survey Record Drainage System
 At Lin Ma Hang Road
 DD90 Temporary Rural Workshop

Scale
 @A0 1:200

Date of Survey:
 June 2023



- Notes :
1. Co-ordinates are relative to Hong Kong Metric Grid (1980)
 2. All Levels are in Metres relative to Principal Datum (P.D.)
 3. Elevation of kerb are referred to bottom of kerb
 4. Dimensions are in Metres unless otherwise shown

- Legends:
- 300Ø As-built Drain Pipe
 - 300U As-built U-Channel
 - +9.711 As-built Invert Level
 - CP As-built Catchpit
 - +10.825 As-built Ground Level

Match Line

DRAWING TITLE :
 As-Built Survey Record Drainage System
 At Lin Ma Hang Road
 DD90 Temporary Rural Workshop

Sheet 2 of 2

Scale
 @A0 1:200

Date of Survey:
 June 2023

Appendix C

Site Photographs

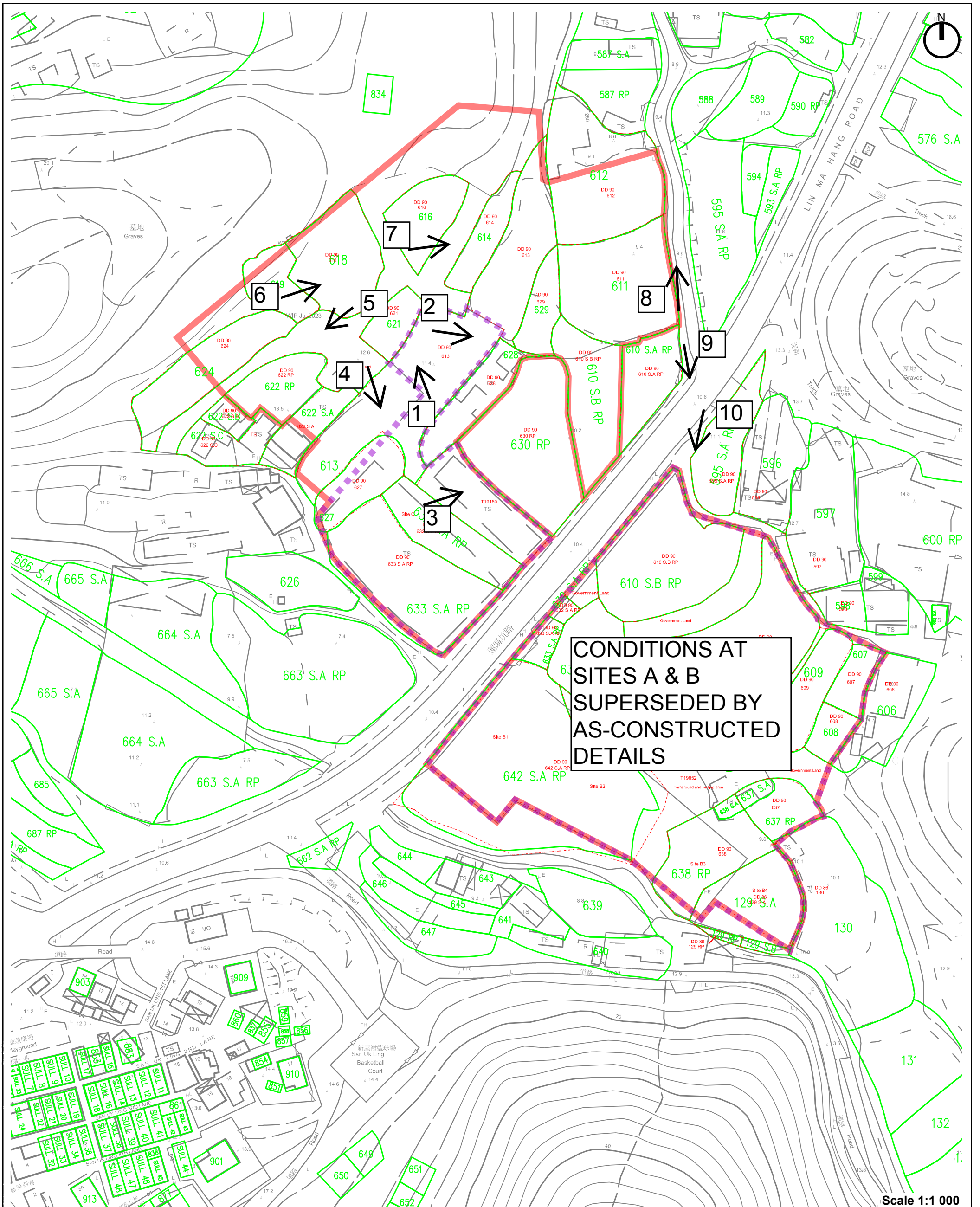

CONDITIONS AT
SITES A & B
SUPERSEDED BY
AS-CONSTRUCTED
DETAILS

Scale 1:1 000

- ▬ Application Site Boundary
- ▬ Planning Approval Boundary
- ▬ Lot Boundary Based on Lot Index Plan
- · - · - Lot Boundary Based on Surveying

← 1 Plate Number and Direction (Indicative only)

AIM
Expert Services

Locations of Site Photographs

C192 – Proposed Rural Workshop (Timber Yard and Sawmill) for a period of 3 years in Various Lots in D.D. 90 and Adjoining Government Land, Lin Ma Hang Road, San Uk Ling, Ma Kam To

Appendix C –Site Photographs (Dated June 2021, March 2022 and December 2023)

See Plan for Locations. Original Site conditions for Sites A and B have been superseded by the As-constructed details (workshops and drainage facilities) and relevant (original) photographs have therefore been omitted from this DIA.



Plate 1 – Small External Catchment (North of Site C)



Plate 2 – Original ground sloping away from Site C



Plate 3 – Existing/original ground sloping away from Site C



Plate 4 – Existing Site C (December 2023)



Plate 5 – Site D



Plate 6 – Sites D and E



Plate 7 – Site E



Plate 8 – Existing Eastern Streamcourse



Plate 9 – Drainage Crossing Beneath Lin Ma Hang Road (view from the North)



Plate 10 – Catchpit at Southern Side of Lin Ma Hang Road

Appendix D

Runoff Calculations

**C192 - Hong Kong & Kowloon Timber Merchants Association Yard at Lin Ma Hang Road
Overall Catchment Areas and Run-off towards Western (Main) Streamcourse (1 in 10 Year)**

Refer:
DSD Stormwater Drainage Manual

Notes:
The existing Site comprises some small buildings, temporary structures & hard paving (concrete); C = 0.95, some hardstanding (broken asphalt), C = 0.7, and some areas of flat vegetation, C = 0.2
The existing areas of paving, etc. are estimated from survey plans, Google Earth and other Site records
The future Site will comprise buildings, flat paving and access roads, etc.; C = 1.0. Also, some landscape buffer zones, C = 0.25
The overall catchment mostly comprises steep naturally vegetated hillsides; C = 0.35
The Site is at Lin Ma Hang Road - North District
The catchments are fairly small, so Rational Method is appropriate.
Runoff from Sites C & D are to be diverted towards the East after the proposed development

Intensity = $a/(t_c+b)^c$

a, b and c from the DSD Stormwater Manual (Table 3d - North Dist

	a	b	c
1 in 10 year	1157.7	19.04	0.597

Catchment	Area (m ²)	Levels (mPD)		Fall (m)	Overland, L (m)	Channel, L (m)	Fall, H (m/100m)	Overland t _c (min)	Velocity (Channel) (m/s)	Flow Time (Channel) (min)	Total t _c [*] (min)	Intensity (mm/h)	Runoff Coefficient	Run-off (m ³ /s)
		Upstream	Downstream											
Existing (Original) Situation for Streamcourse to the West														
The Site														
Sites A & B	9,020	11.4	9.18	2.19	96	-	2.3	4.7	-	-	4.7	175		
Structures/Temporary Structures & Hard Paving (Paved)	902												0.95	0.042
Hardstanding (Paved)	2,951												0.75	0.107
Vegetated Areas (Unpaved)	5,168												0.20	0.050
Total														0.199
Western Site (Sites C and D - Catchments 1 & 3)	8,209	26	10.35	15.65	162	-	9.7	6.0	-	-	6.0	169		
Temporary Structures & Hard Paving (Paved)	1,100												0.95	0.049
Hardstanding (Paved)	1,714												0.75	0.060
Vegetated Areas (Unpaved)	5,395												0.20	0.051
Total														0.160
Overall Catchment														
Overall Catchment Area	385,662	80	25	55	238	652	23.1	5.1	1	10.9	15.9	139		
Paving @ 2.5% of the Area (Paved)	96,416												0.90	3.345
Vegetated Areas (Unpaved)	289,247												0.35	3.902
Total														7.247
Sites A, B & C contribution to Overall Catchment Runoff												139		
Total Area	17,229													
Structures/Temporary Structures & Hard Paving (Paved)	2,002												0.95	0.073
Hardstanding (Paved)	4,665												0.75	0.135
Vegetated Areas (Unpaved)	10,563												0.20	0.081
Total														0.290
Future Situation														
The Site														
Sites A & B	9,020										5.0	173		
Buildings and Paving (Paved)	8,868												1.00	0.428
Buffer Zone (Unpaved)	152												0.20	0.001
Total														0.429
Overall Catchment														
Sites A & B contribution to Overall Catchment Runoff												139		
Total Area	9,020													
Buildings and Paving (Paved)	8,868												0.95	0.325
Vegetated Areas (Unpaved)	152												0.20	0.001
Total														0.326

*Assumed t_c for Future Situation

C192 - Hong Kong & Kowloon Timber Merchants Association Yard at Lin Ma Hang Road
Overall Catchment Areas and Run-off (1 in 10 Year)

Refer:
 DSD Stormwater Drainage Manual

Notes:
 The existing (original) Site comprises mostly areas of flat vegetation, with some mild slopes, C = 0.2
 The existing areas of paving, etc. are estimated from survey plans and other Site records
 The future Site will comprise buildings, flat paving and access roads, etc.; C = 1.0. Also, some landscape buffer zones, C = 0.25
 The overall upstream catchment mostly comprises steep naturally vegetated hillsides; C = 0.35
 The Site is at Lin Ma Hang Road - North District
 The catchments are fairly small, so Rational Method is appropriate.
 Runoff from Sites C & D are to be diverted towards the East after the proposed development

a, b and c from the DSD Stormwater Manual (Table 3d - North Dist

Intensity = $a/(t_c + b)^c$

	a	b	c
1 in 10 year	1157.7	19.04	0.597

Catchment	Area (m ²)	Levels (mPD)		Fall (m)	Overland, L (m)	Channel, L (m)	Fall, H (m/100m)	Overland t _c (min)	Velocity (Channel) (m/s)	Flow Time (Channel) (min)	Total t _c [*] (min)	Intensity (mm/h)	Runoff Coefficient	Run-off (m ³ /s)
		Upstream	Downstream											
Existing (Original) Situation for Streamcourse to the East														
Overall Catchment														
Upstream Catchment	17,015	75.0	10	65.0	254	-	25.6	7.3	-	-	7.3	164		
Structures/Temporary Structures & Hard Paving (Paved)	3,748												0.95	0.163
Vegetated Hills (Unpaved)	13,267												0.35	0.212
Total														0.375
Site E (Catchments 2 and 4, plus 630RP)	7,023	22	11.4	10.6	160	-	6.6	6.5	-	-	6.5	167		
Temporary Structures & Hard Paving (Paved)	0												0.95	0.000
Hardstanding (Paved)	351												0.75	0.012
Vegetated Areas (Unpaved)	6,672												0.20	0.062
Total														0.074
Total to Eastern Stream														
Overall Discharge to Eastern Stream from Upstream Catchment and the Site												164		
Total Area	24,038													
Structures/Temporary Structures & Hard Paving (Paved)	3,748												0.95	0.163
Vegetated Areas (Unpaved)	6,672												0.20	0.061
Vegetated Hills (Unpaved)	13,267												0.35	0.212
Total														0.436
Future Situation														
Overall Catchment														
Upstream Catchment	17,015	75.0	10	65	254	-	25.6	7.3	-	-	7.3	164		
Structures/Temporary Structures & Hard Paving (Paved)	3,748												0.95	0.163
Vegetated Areas (Unpaved)	13,267												0.35	0.212
Total														0.375
The Site (Sites C, D & E plus local external catchments)	15,232										6.0	169		
Buildings and Paving (Paved)	11,389												1.00	0.536
Buffer Zone (Unpaved)	104												0.20	0.001
Upstream Catchments (3 & 4)	2,649												0.35	0.044
Lot 630RP	1,090												0.20	0.010
Total														0.591
Total to Eastern Stream														
Overall Discharge to Eastern Stream from Upstream Catchment and the Site												164		
Total Area	32,247													
Site Structures & Hard Paving (Paved)	11,389												1.00	0.521
Upstream Temporary Structures (Paved)	3,748												0.95	0.163
Vegetated Hills (Unpaved)	15,916												0.35	0.255
Total														0.938

*Assumed t_c for Future Situation

Appendix E

Hydrograph and Storage Calculations

C192 - Hong Kong & Kowloon Timber Merchants Association Yard at Lin Ma Hang Road
Hydrographs and Storage - Sites A & B
10-Minute Duration

Hydrographs and Storage Volumes based on full hydrographs using storm profiles from the DSD SDM 5th Edition
(Refer to SDM Table 5d - Storm Profile for North District and Figure 6)

Assume Site Areas are equally divided over the time of Concentration, i.e. $t_c = 5$ minutes, so 20% of the Site over each minute

	(m ²)	C Value	Average C
Site Area	9,020		0.987
Paved	8,868	1.00	
Unpaved	152	0.20	

Case 1 - 10-minute duration, 1 in 10-year

Time	Rainfall Intensity	Area A, m ² = C =	Area 1 Runoff	Area 2 Runoff	Area 3 Runoff	Area 4 Runoff	Area 5 Runoff	Overall Runoff Hydrograph	Original Peak Discharge	Excess Discharge	Excess Volume in Time Period
(min)	(mm/hr)		(m ³ /s)	(m ³ /s)	(m ³ /s)	(m ³ /s)	(m ³ /s)	(m ³ /s)	(m ³ /s)	(m ³ /s)	(m ³)
0	0		0.000	0.000	0.000	0.000	0.000	0.000	0.200	0.000	0.0
0.5	123		0.061	0.000	0.000	0.000	0.000	0.061	0.200	0.000	0.0
1	133		0.066	0.000	0.000	0.000	0.000	0.066	0.200	0.000	0.0
1.5	133		0.066	0.061	0.000	0.000	0.000	0.127	0.200	0.000	0.0
2	145		0.072	0.066	0.000	0.000	0.000	0.138	0.200	0.000	0.0
2.5	145		0.072	0.066	0.061	0.000	0.000	0.198	0.200	0.000	0.0
3	160		0.079	0.072	0.066	0.000	0.000	0.217	0.200	0.017	0.5
3.5	160		0.079	0.072	0.066	0.061	0.000	0.278	0.200	0.078	2.3
4	177		0.088	0.079	0.072	0.066	0.000	0.304	0.200	0.104	3.1
4.5	177		0.088	0.079	0.072	0.066	0.061	0.365	0.200	0.165	5.0
5	193		0.095	0.088	0.079	0.072	0.066	0.400	0.200	0.200	6.0
5.5	193		0.095	0.088	0.079	0.072	0.066	0.400	0.200	0.200	6.0
6	177		0.088	0.095	0.088	0.079	0.072	0.422	0.200	0.222	6.6
6.5	177		0.088	0.095	0.088	0.079	0.072	0.422	0.200	0.222	6.6
7	160		0.079	0.088	0.095	0.088	0.079	0.429	0.200	0.229	6.9
7.5	160		0.079	0.088	0.095	0.088	0.079	0.429	0.200	0.229	6.9
8	145		0.072	0.079	0.088	0.095	0.088	0.422	0.200	0.222	6.6
8.5	145		0.072	0.079	0.088	0.095	0.088	0.422	0.200	0.222	6.6
9	133		0.066	0.072	0.079	0.088	0.095	0.400	0.200	0.200	6.0
9.5	133		0.066	0.072	0.079	0.088	0.095	0.400	0.200	0.200	6.0
10	123		0.061	0.066	0.072	0.079	0.088	0.365	0.200	0.165	5.0
10.5	0		0.000	0.066	0.072	0.079	0.088	0.304	0.200	0.104	3.1
11	0		0.000	0.061	0.066	0.072	0.079	0.278	0.200	0.078	2.3
11.5	0		0.000	0.000	0.066	0.072	0.079	0.217	0.200	0.017	0.5
12	0		0.000	0.000	0.061	0.066	0.072	0.198	0.200	0.000	0.0
12.5	0		0.000	0.000	0.000	0.066	0.072	0.138	0.200	0.000	0.0
13	0		0.000	0.000	0.000	0.061	0.066	0.127	0.200	0.000	0.0
13.5	0		0.000	0.000	0.000	0.000	0.066	0.066	0.200	0.000	0.0
14	0		0.000	0.000	0.000	0.000	0.061	0.061	0.200	0.000	0.0
14.5	0		0.000	0.000	0.000	0.000	0.000	0.000	0.200	0.000	0.0
15	0		0.000	0.000	0.000	0.000	0.000	0.000	0.200	0.000	0.0

Total Excess Volume for Storage = 86.1 m³

C192 - Hong Kong & Kowloon Timber Merchants Association Yard at Lin Ma Hang Road
Hydrographs and Storage - Sites A & B
30-Minute Duration

Hydrographs and Storage Volumes based on full hydrographs using storm profiles from the DSD SDM 5th Edition
(Refer to SDM Table 5d - Storm Profile for North District and Figure 6)

Assume Site Areas are equally divided over the time of Concentration, i.e. $t_c = 5$ minutes, so 20% of the Site over each minute

	(m ²)	C Value	Average C
Site Area	9,020		0.987
Paved	8,868	1.00	
Unpaved	152	0.20	

Case 2 - 30-minute duration, 1 in 10-year

Time	Rainfall Intensity	Area m ² = C =	Area 1 1804 0.987 Runoff (m ³ /s)	Area 2 1804 0.987 Runoff (m ³ /s)	Area 3 1804 0.987 Runoff (m ³ /s)	Area 4 1804 0.987 Runoff (m ³ /s)	Area 5 1804 0.987 Runoff (m ³ /s)	Overall Runoff Hydrograph (m ³ /s)	Original Peak Discharge (m ³ /s)	Excess Discharge (m ³ /s)	Excess Volume in Time Period (m ³)
(min)	(mm/hr)										
0	0		0.000	0.000	0.000	0.000	0.000	0.000	0.200	0.000	0.0
0.5	72		0.036	0.000	0.000	0.000	0.000	0.036	0.200	0.000	0.0
1	75		0.037	0.000	0.000	0.000	0.000	0.037	0.200	0.000	0.0
1.5	75		0.037	0.036	0.000	0.000	0.000	0.073	0.200	0.000	0.0
2	78		0.039	0.037	0.000	0.000	0.000	0.076	0.200	0.000	0.0
2.5	78		0.039	0.037	0.036	0.000	0.000	0.111	0.200	0.000	0.0
3	82		0.041	0.039	0.037	0.000	0.000	0.116	0.200	0.000	0.0
3.5	82		0.041	0.039	0.037	0.036	0.000	0.152	0.200	0.000	0.0
4	86		0.043	0.041	0.039	0.037	0.000	0.159	0.200	0.000	0.0
4.5	86		0.043	0.041	0.039	0.037	0.036	0.194	0.200	0.000	0.0
5	90		0.045	0.043	0.041	0.039	0.037	0.203	0.200	0.003	0.1
5.5	90		0.045	0.043	0.041	0.039	0.037	0.203	0.200	0.003	0.1
6	95		0.047	0.045	0.043	0.041	0.039	0.213	0.200	0.013	0.4
6.5	95		0.047	0.045	0.043	0.041	0.039	0.213	0.200	0.013	0.4
7	101		0.050	0.047	0.045	0.043	0.041	0.225	0.200	0.025	0.7
7.5	101		0.050	0.047	0.045	0.043	0.041	0.225	0.200	0.025	0.7
8	107		0.053	0.050	0.047	0.045	0.043	0.237	0.200	0.037	1.1
8.5	107		0.053	0.050	0.047	0.045	0.043	0.237	0.200	0.037	1.1
9	115		0.057	0.053	0.050	0.047	0.045	0.251	0.200	0.051	1.5
9.5	115		0.057	0.053	0.050	0.047	0.045	0.251	0.200	0.051	1.5
10	123		0.061	0.057	0.053	0.050	0.047	0.268	0.200	0.068	2.0
10.5	123		0.061	0.057	0.053	0.050	0.047	0.268	0.200	0.068	2.0
11	133		0.066	0.061	0.057	0.053	0.050	0.286	0.200	0.086	2.6
11.5	133		0.066	0.061	0.057	0.053	0.050	0.286	0.200	0.086	2.6
12	145		0.072	0.066	0.061	0.057	0.053	0.308	0.200	0.108	3.2
12.5	145		0.072	0.066	0.061	0.057	0.053	0.308	0.200	0.108	3.2
13	160		0.079	0.072	0.066	0.061	0.057	0.334	0.200	0.134	4.0
13.5	160		0.079	0.072	0.066	0.061	0.057	0.334	0.200	0.134	4.0
14	177		0.088	0.079	0.072	0.066	0.061	0.365	0.200	0.165	5.0
14.5	177		0.088	0.079	0.072	0.066	0.061	0.365	0.200	0.165	5.0
15	193		0.095	0.088	0.079	0.072	0.066	0.400	0.200	0.200	6.0
15.5	193		0.095	0.088	0.079	0.072	0.066	0.400	0.200	0.200	6.0
16	177		0.088	0.079	0.072	0.066	0.061	0.422	0.200	0.222	6.6
16.5	177		0.088	0.079	0.072	0.066	0.061	0.422	0.200	0.222	6.6
17	160		0.079	0.072	0.066	0.061	0.057	0.429	0.200	0.229	6.9
17.5	160		0.079	0.072	0.066	0.061	0.057	0.429	0.200	0.229	6.9
18	145		0.072	0.066	0.061	0.057	0.053	0.422	0.200	0.222	6.6
18.5	145		0.072	0.066	0.061	0.057	0.053	0.422	0.200	0.222	6.6
19	133		0.066	0.061	0.057	0.053	0.050	0.400	0.200	0.200	6.0
19.5	133		0.066	0.061	0.057	0.053	0.050	0.400	0.200	0.200	6.0
20	123		0.061	0.057	0.053	0.050	0.047	0.365	0.200	0.165	5.0
20.5	123		0.061	0.057	0.053	0.050	0.047	0.365	0.200	0.165	5.0
21	115		0.057	0.053	0.050	0.047	0.045	0.334	0.200	0.134	4.0
21.5	115		0.057	0.053	0.050	0.047	0.045	0.334	0.200	0.134	4.0
22	107		0.053	0.050	0.047	0.045	0.043	0.308	0.200	0.108	3.2
22.5	107		0.053	0.050	0.047	0.045	0.043	0.308	0.200	0.108	3.2
23	101		0.050	0.047	0.045	0.043	0.041	0.286	0.200	0.086	2.6
23.5	101		0.050	0.047	0.045	0.043	0.041	0.286	0.200	0.086	2.6
24	95		0.047	0.045	0.043	0.041	0.039	0.268	0.200	0.068	2.0
24.5	95		0.047	0.045	0.043	0.041	0.039	0.268	0.200	0.068	2.0
25	90		0.045	0.043	0.041	0.039	0.037	0.251	0.200	0.051	1.5
25.5	90		0.045	0.043	0.041	0.039	0.037	0.251	0.200	0.051	1.5
26	86		0.043	0.041	0.039	0.037	0.036	0.237	0.200	0.037	1.1
26.5	86		0.043	0.041	0.039	0.037	0.036	0.237	0.200	0.037	1.1
27	82		0.041	0.039	0.037	0.036	0.035	0.225	0.200	0.025	0.7
27.5	82		0.041	0.039	0.037	0.036	0.035	0.225	0.200	0.025	0.7
28	78		0.039	0.037	0.036	0.035	0.034	0.213	0.200	0.013	0.4
28.5	78		0.039	0.037	0.036	0.035	0.034	0.213	0.200	0.013	0.4
29	75		0.037	0.036	0.035	0.034	0.033	0.203	0.200	0.003	0.1
29.5	75		0.037	0.036	0.035	0.034	0.033	0.203	0.200	0.003	0.1
30	72		0.036	0.035	0.034	0.033	0.032	0.194	0.200	0.000	0.0
30.5	0		0.000	0.037	0.036	0.035	0.034	0.159	0.200	0.000	0.0
31	0		0.000	0.036	0.035	0.034	0.033	0.152	0.200	0.000	0.0
31.5	0		0.000	0.036	0.035	0.034	0.033	0.152	0.200	0.000	0.0
32	0		0.000	0.036	0.035	0.034	0.033	0.152	0.200	0.000	0.0
32.5	0		0.000	0.036	0.035	0.034	0.033	0.152	0.200	0.000	0.0
33	0		0.000	0.036	0.035	0.034	0.033	0.152	0.200	0.000	0.0
33.5	0		0.000	0.036	0.035	0.034	0.033	0.152	0.200	0.000	0.0
34	0		0.000	0.036	0.035	0.034	0.033	0.152	0.200	0.000	0.0
34.5	0		0.000	0.036	0.035	0.034	0.033	0.152	0.200	0.000	0.0
35	0		0.000	0.036	0.035	0.034	0.033	0.152	0.200	0.000	0.0

Total Excess Volume for Storage = 147.3 m³

C192 - Hong Kong & Kowloon Timber Merchants Association Yard at Lin Ma Hang Road
Hydrographs and Storage - Sites A & B
60-Minute Duration

Hydrographs and Storage Volumes based on full hydrographs using storm profiles from the DSD SDM 5th Edition
 (Refer to SDM Table 5d - Storm Profile for North District and Figure 6)

Assume Site Areas are equally divided over the time of Concentration, i.e. $t_c = 5$ minutes, so 20% of the Site over each minute

	(m ²)	C Value	Average C
Site Area	9,020		0.987
Paved	8,868	1.00	
Unpaved	152	0.20	

Case 3 - 60-minute duration, 1 in 10-year

Time	Rainfall Intensity	Area m ² = C =	Area 1 1804 0.987 Runoff (m ³ /s)	Area 2 1804 0.987 Runoff (m ³ /s)	Area 3 1804 0.987 Runoff (m ³ /s)	Area 4 1804 0.987 Runoff (m ³ /s)	Area 5 1804 0.987 Runoff (m ³ /s)	Overall Runoff Hydrograph (m ³ /s)	Original Peak Discharge (m ³ /s)	Excess Discharge (m ³ /s)	Excess Volume in Time Period (m ³)
0	0		0.000	0.000	0.000	0.000	0.000	0.000	0.200	0.000	0.0
0.5	47		0.023	0.000	0.000	0.000	0.000	0.023	0.200	0.000	0.0
1	48		0.024	0.000	0.000	0.000	0.000	0.024	0.200	0.000	0.0
1.5	48		0.024	0.023	0.000	0.000	0.000	0.047	0.200	0.000	0.0
2	49		0.024	0.024	0.000	0.000	0.000	0.048	0.200	0.000	0.0
2.5	49		0.024	0.024	0.023	0.000	0.000	0.071	0.200	0.000	0.0
3	50		0.025	0.024	0.024	0.000	0.000	0.073	0.200	0.000	0.0
3.5	50		0.025	0.024	0.024	0.023	0.000	0.096	0.200	0.000	0.0
4	51		0.025	0.025	0.024	0.024	0.000	0.098	0.200	0.000	0.0
4.5	51		0.025	0.025	0.024	0.024	0.023	0.121	0.200	0.000	0.0
5	52		0.026	0.025	0.024	0.024	0.024	0.124	0.200	0.000	0.0
5.5	52		0.026	0.025	0.025	0.024	0.024	0.124	0.200	0.000	0.0
6	54		0.027	0.026	0.025	0.025	0.024	0.127	0.200	0.000	0.0
6.5	54		0.027	0.026	0.025	0.025	0.024	0.127	0.200	0.000	0.0
7	55		0.027	0.027	0.026	0.025	0.025	0.130	0.200	0.000	0.0
7.5	55		0.027	0.027	0.026	0.025	0.025	0.130	0.200	0.000	0.0
8	57		0.028	0.027	0.027	0.026	0.025	0.133	0.200	0.000	0.0
8.5	57		0.028	0.027	0.027	0.026	0.025	0.133	0.200	0.000	0.0
9	59		0.029	0.028	0.027	0.027	0.026	0.137	0.200	0.000	0.0
9.5	59		0.029	0.028	0.027	0.027	0.026	0.137	0.200	0.000	0.0
10	60		0.030	0.029	0.028	0.027	0.027	0.141	0.200	0.000	0.0
10.5	60		0.030	0.029	0.028	0.027	0.027	0.141	0.200	0.000	0.0
11	62		0.031	0.029	0.028	0.028	0.027	0.145	0.200	0.000	0.0
11.5	62		0.031	0.030	0.029	0.028	0.027	0.145	0.200	0.000	0.0
12	64		0.032	0.031	0.030	0.029	0.028	0.149	0.200	0.000	0.0
12.5	64		0.032	0.031	0.030	0.029	0.028	0.149	0.200	0.000	0.0
13	67		0.033	0.032	0.031	0.030	0.029	0.154	0.200	0.000	0.0
13.5	67		0.033	0.032	0.031	0.030	0.029	0.154	0.200	0.000	0.0
14	69		0.034	0.033	0.032	0.031	0.030	0.159	0.200	0.000	0.0
14.5	69		0.034	0.033	0.032	0.031	0.030	0.159	0.200	0.000	0.0
15	72		0.036	0.034	0.033	0.032	0.031	0.165	0.200	0.000	0.0
15.5	72		0.036	0.034	0.033	0.032	0.031	0.165	0.200	0.000	0.0
16	75		0.037	0.036	0.034	0.033	0.032	0.172	0.200	0.000	0.0
16.5	75		0.037	0.036	0.034	0.033	0.032	0.172	0.200	0.000	0.0
17	78		0.039	0.037	0.036	0.034	0.033	0.179	0.200	0.000	0.0
17.5	78		0.039	0.037	0.036	0.034	0.033	0.179	0.200	0.000	0.0
18	82		0.041	0.039	0.037	0.036	0.034	0.186	0.200	0.000	0.0
18.5	82		0.041	0.039	0.037	0.036	0.034	0.186	0.200	0.000	0.0
19	86		0.043	0.041	0.039	0.037	0.036	0.194	0.200	0.000	0.0
19.5	86		0.043	0.041	0.039	0.037	0.036	0.194	0.200	0.000	0.0
20	90		0.045	0.043	0.041	0.039	0.037	0.203	0.200	0.003	0.1
20.5	90		0.045	0.043	0.041	0.039	0.037	0.203	0.200	0.003	0.1
21	95		0.047	0.045	0.043	0.041	0.039	0.213	0.200	0.013	0.4
21.5	95		0.047	0.045	0.043	0.041	0.039	0.213	0.200	0.013	0.4
22	101		0.050	0.047	0.045	0.043	0.041	0.225	0.200	0.025	0.7
22.5	101		0.050	0.047	0.045	0.043	0.041	0.225	0.200	0.025	0.7
23	107		0.053	0.050	0.047	0.045	0.043	0.237	0.200	0.037	1.1
23.5	107		0.053	0.050	0.047	0.045	0.043	0.237	0.200	0.037	1.1
24	115		0.057	0.053	0.050	0.047	0.045	0.251	0.200	0.051	1.5
24.5	115		0.057	0.053	0.050	0.047	0.045	0.251	0.200	0.051	1.5
25	123		0.061	0.057	0.053	0.050	0.047	0.268	0.200	0.068	2.0
25.5	123		0.061	0.057	0.053	0.050	0.047	0.268	0.200	0.068	2.0
26	133		0.066	0.061	0.057	0.053	0.050	0.286	0.200	0.086	2.6
26.5	133		0.066	0.061	0.057	0.053	0.050	0.286	0.200	0.086	2.6
27	145		0.072	0.066	0.061	0.057	0.053	0.308	0.200	0.108	3.2
27.5	145		0.072	0.066	0.061	0.057	0.053	0.308	0.200	0.108	3.2
28	160		0.079	0.072	0.066	0.061	0.057	0.334	0.200	0.134	4.0
28.5	160		0.079	0.072	0.066	0.061	0.057	0.334	0.200	0.134	4.0
29	177		0.088	0.079	0.072	0.066	0.061	0.365	0.200	0.165	5.0
29.5	177		0.088	0.079	0.072	0.066	0.061	0.365	0.200	0.165	5.0
30	193		0.095	0.088	0.079	0.072	0.066	0.400	0.200	0.200	6.0
30.5	193		0.095	0.088	0.079	0.072	0.066	0.400	0.200	0.200	6.0
31	177		0.088	0.085	0.088	0.079	0.072	0.422	0.200	0.222	6.6
31.5	177		0.088	0.085	0.088	0.079	0.072	0.422	0.200	0.222	6.6
32	160		0.079	0.088	0.095	0.088	0.079	0.429	0.200	0.229	6.9
32.5	160		0.079	0.088	0.095	0.088	0.079	0.429	0.200	0.229	6.9
33	145		0.072	0.079	0.088	0.095	0.088	0.422	0.200	0.222	6.6
33.5	145		0.072	0.079	0.088	0.095	0.088	0.422	0.200	0.222	6.6
34	133		0.066	0.072	0.079	0.088	0.095	0.400	0.200	0.200	6.0
34.5	133		0.066	0.072	0.079	0.088	0.095	0.400	0.200	0.200	6.0
35	123		0.061	0.066	0.072	0.079	0.088	0.365	0.200	0.165	5.0
35.5	123		0.061	0.066	0.072	0.079	0.088	0.365	0.200	0.165	5.0
36	115		0.057	0.061	0.066	0.072	0.079	0.334	0.200	0.134	4.0
36.5	115		0.057	0.061	0.066	0.072	0.079	0.334	0.200	0.134	4.0
37	107		0.053	0.057	0.061	0.066	0.072	0.308	0.200	0.108	3.2
37.5	107		0.053	0.057	0.061	0.066	0.072	0.308	0.200	0.108	3.2
38	101		0.050	0.053	0.057	0.061	0.066	0.286	0.200	0.086	2.6
38.5	101		0.050	0.053	0.057	0.061	0.066	0.286	0.200	0.086	2.6
39	95		0.047	0.050	0.053	0.057	0.061	0.268	0.200	0.068	2.0
39.5	95		0.047	0.050	0.053	0.057	0.061	0.268	0.200	0.068	2.0
40	90		0.045	0.047	0.050	0.053	0.057	0.251	0.200	0.051	1.5
40.5	90		0.045	0.047	0.050	0.053	0.057	0.251	0.200	0.051	1.5
41	86		0.043	0.045	0.047	0.050	0.053	0.237	0.200	0.037	1.1
41.5	86		0.043	0.045	0.047	0.050	0.053	0.237	0.200	0.037	1.1
42	82		0.041	0.043	0.045	0.047	0.050	0.225	0.200	0.025	0.7
42.5	82		0.041	0.043	0.045	0.047	0.050	0.225	0.200	0.025	0.7
43	78		0.039	0.041	0.043	0.045	0.047	0.213	0.200	0.013	0.4
43.5	78		0.039	0.041	0.043	0.045	0.047	0.213	0.200	0.013	0.4
44	75		0.037	0.039	0.041	0.043	0.045	0.203	0.200	0.003	0.1
44.5	75		0.037	0.039	0.041	0.043	0.045	0.203	0.200	0.003	0.1
45	72		0.036	0.037	0.039	0.041	0.043	0.194	0.200	0.000	0.0
45.5	72		0.036	0.037	0.039	0.041	0.043	0.194	0.200	0.000	0.0
46	69		0.034	0.036	0.037	0.039	0.041	0.186	0.200	0.000	0.0
46.5	69		0.034	0.036	0.037	0.039	0.041	0.186	0.200	0.000	0.0
47	67		0.033	0.034	0.036	0.037	0.039	0.179	0.200	0.000	0.0
47.5	67		0.033	0.034	0.036	0.037	0.039	0.179	0.200	0.000	0.0
48	64		0.032	0.033	0.034	0.036	0.037	0.172	0.200	0.000	0.0
48.5	64		0.032	0.033	0.034	0.036	0.037	0.172	0.200	0.000	0.0
49	62		0.031	0.032	0.033	0.034	0.036	0.165	0.200	0.000	0.0
49.5	62		0.031	0.032	0.033	0.034	0.036	0.165	0.200	0.000	0.0
50	60		0.030	0.031	0.032	0.033	0.034	0.159	0.200	0.000	0.0
50.5	60		0.030	0.031	0.032	0.033	0.034	0.159	0.200	0.000	0.0
51	59		0.029	0.030	0.031	0.032	0.033	0.154	0.200	0.0	

Sites A & B 10-Minute Runoff Hydrograph

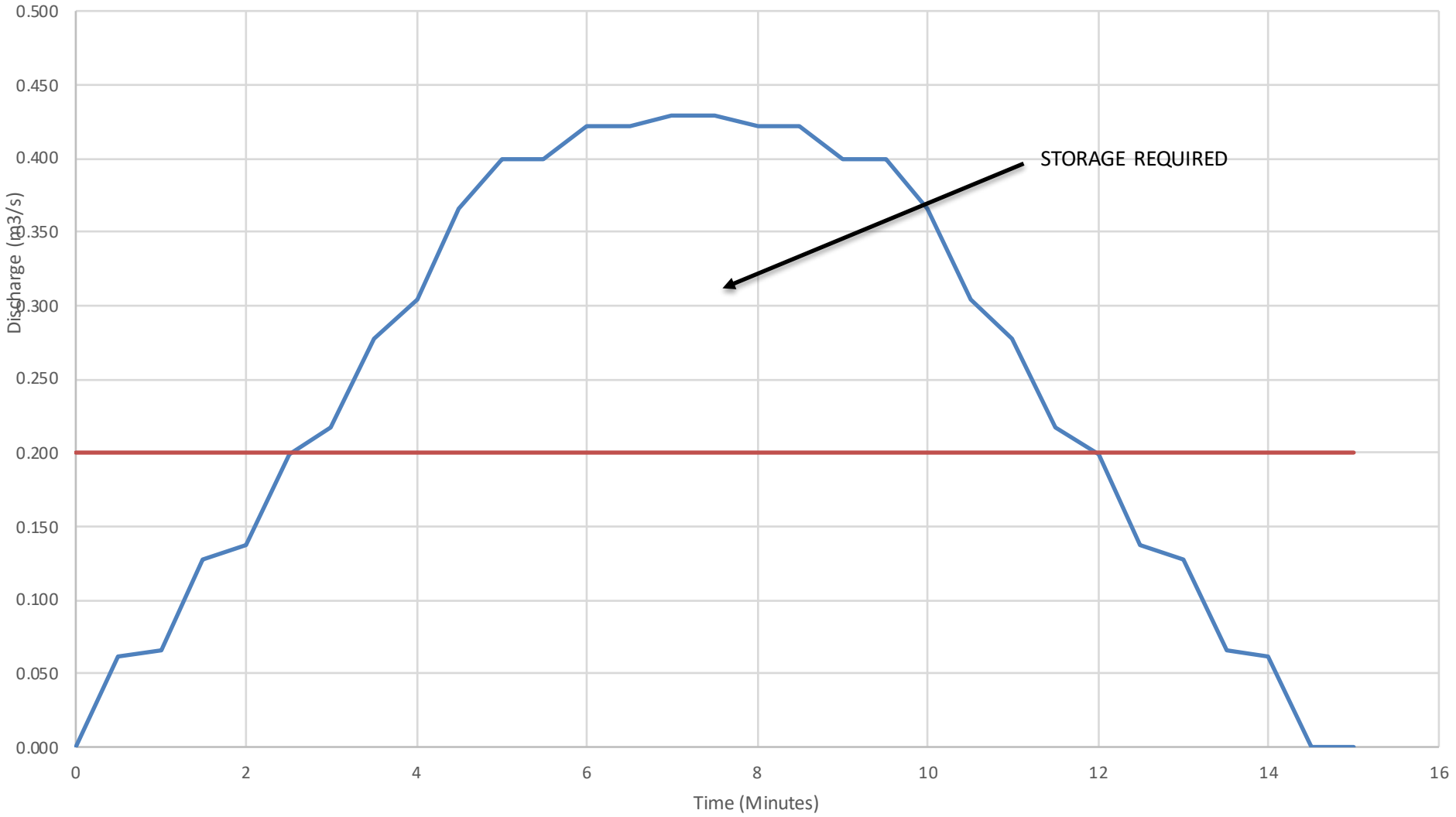

— Runoff Hydrograph — Original Peak Discharge

Sites A & B 30-Minute Runoff Hydrograph

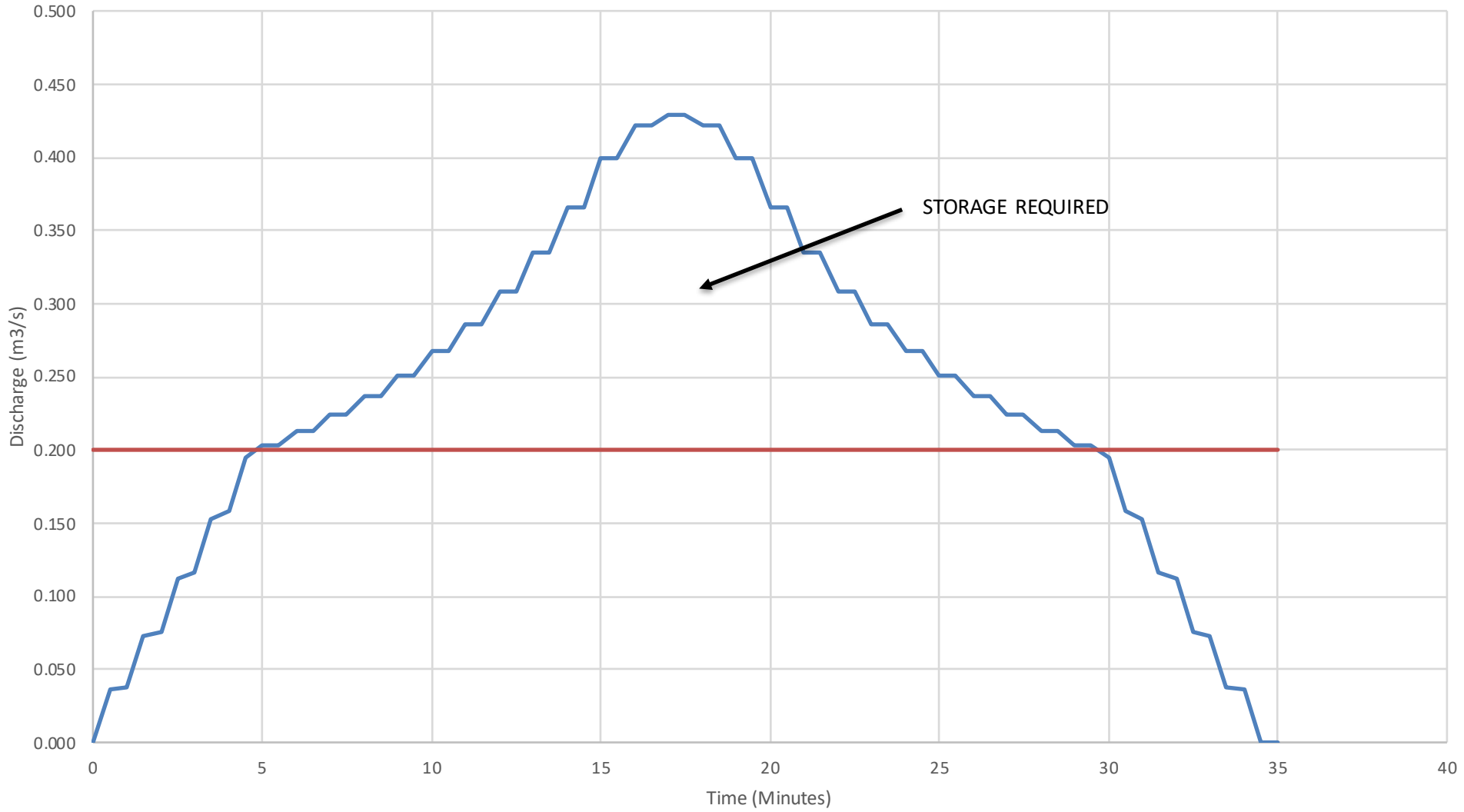

Runoff Hydrograph Original Peak Discharge

Sites A & B 60-Minute Runoff Hydrograph

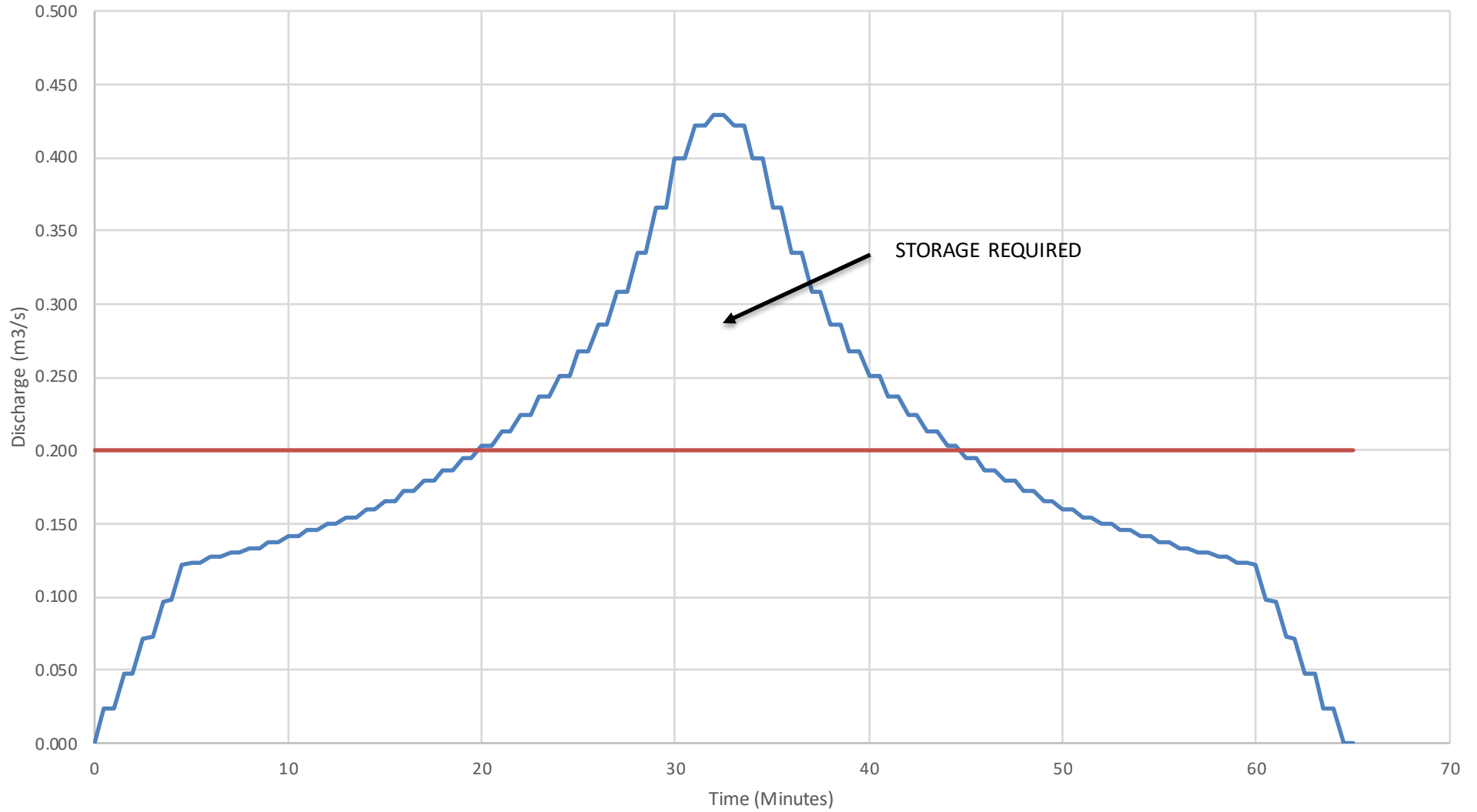

— Runoff Hydrograph — Original Peak Discharge

C192 - Hong Kong & Kowloon Timber Merchants Association Yard at Lin Ma Hang Road
Hydrographs and Storage - Sites C, D and E
10-Minute Duration

Hydrographs and Storage Volumes based on full hydrographs using storm profiles from the DSD SDM 5th Edition
(Refer to SDM Table 5d - Storm Profile for North District and Figure 6)

Assume Site Areas are equally divided over the time of Concentration, i.e. $t_c = 6$ minutes, so 1/6 of the Site over each minute

	(m ²)	C Value	Average C
Site Area	15,232		0.810
Paved	11,389	1.00	
Buffer Zone	104	0.20	
Local Catchments	2,649	0.35	

Case 1 - 10-minute duration, 1 in 10-year

Time (min)	Rainfall Intensity (mm/hr)	Area m ² = C =	Area 1 2538.7 0.810 Runoff (m ³ /s)	Area 2 2538.7 0.810 Runoff (m ³ /s)	Area 3 2538.7 0.810 Runoff (m ³ /s)	Area 4 2538.7 0.810 Runoff (m ³ /s)	Area 5 2538.7 0.810 Runoff (m ³ /s)	Area 6 2538.7 0.810 Runoff (m ³ /s)	Overall Runoff Hydrograph (m ³ /s)	Proposed Peak Discharge (m ³ /s)	Excess Discharge (m ³ /s)	Excess Volume in Time Period (m ³)
0	0		0.000	0.000	0.000	0.000	0.000	0.000	0.000	0.250	0.000	0.0
0.5	115		0.066	0.000	0.000	0.000	0.000	0.000	0.066	0.250	0.000	0.0
1	123		0.070	0.000	0.000	0.000	0.000	0.000	0.070	0.250	0.000	0.0
1.5	123		0.070	0.066	0.000	0.000	0.000	0.000	0.136	0.250	0.000	0.0
2	133		0.076	0.070	0.000	0.000	0.000	0.000	0.146	0.250	0.000	0.0
2.5	133		0.076	0.070	0.066	0.000	0.000	0.000	0.212	0.250	0.000	0.0
3	145		0.083	0.076	0.070	0.000	0.000	0.000	0.229	0.250	0.000	0.0
3.5	145		0.083	0.076	0.070	0.066	0.000	0.000	0.295	0.250	0.045	1.3
4	160		0.091	0.083	0.076	0.070	0.000	0.000	0.321	0.250	0.071	2.1
4.5	160		0.091	0.083	0.076	0.070	0.066	0.000	0.386	0.250	0.136	4.1
5	177		0.101	0.091	0.083	0.076	0.070	0.000	0.422	0.250	0.172	5.2
5.5	177		0.101	0.091	0.083	0.076	0.070	0.066	0.488	0.250	0.238	7.1
6	193		0.110	0.101	0.091	0.083	0.076	0.070	0.532	0.250	0.282	8.5
6.5	193		0.110	0.101	0.091	0.083	0.076	0.070	0.532	0.250	0.282	8.5
7	177		0.101	0.110	0.101	0.091	0.083	0.076	0.563	0.250	0.313	9.4
7.5	177		0.101	0.110	0.101	0.091	0.083	0.076	0.563	0.250	0.313	9.4
8	160		0.091	0.101	0.110	0.101	0.091	0.083	0.578	0.250	0.328	9.9
8.5	160		0.091	0.101	0.110	0.101	0.091	0.083	0.578	0.250	0.328	9.9
9	145		0.083	0.091	0.101	0.110	0.101	0.091	0.578	0.250	0.328	9.9
9.5	145		0.083	0.091	0.101	0.110	0.101	0.091	0.578	0.250	0.328	9.9
10	133		0.076	0.083	0.091	0.101	0.110	0.101	0.563	0.250	0.313	9.4
10.5	133		0.076	0.083	0.091	0.101	0.110	0.101	0.563	0.250	0.313	9.4
11	123		0.070	0.076	0.083	0.091	0.101	0.110	0.532	0.250	0.282	8.5
11.5	123		0.070	0.076	0.083	0.091	0.101	0.110	0.532	0.250	0.282	8.5
12	115		0.066	0.070	0.076	0.083	0.091	0.101	0.488	0.250	0.238	7.1
12.5	0		0.000	0.070	0.076	0.083	0.091	0.101	0.422	0.250	0.172	5.2
13	0		0.000	0.066	0.070	0.076	0.083	0.091	0.386	0.250	0.136	4.1
13.5	0		0.000	0.000	0.070	0.076	0.083	0.091	0.321	0.250	0.071	2.1
14	0		0.000	0.000	0.066	0.070	0.076	0.083	0.295	0.250	0.045	1.3
14.5	0		0.000	0.000	0.000	0.070	0.076	0.083	0.229	0.250	0.000	0.0
15	0		0.000	0.000	0.000	0.066	0.070	0.076	0.136	0.250	0.000	0.0
15.5	0		0.000	0.000	0.000	0.000	0.070	0.076	0.070	0.250	0.000	0.0
16	0		0.000	0.000	0.000	0.000	0.066	0.070	0.066	0.250	0.000	0.0
16.5	0		0.000	0.000	0.000	0.000	0.000	0.070	0.000	0.250	0.000	0.0
17	0		0.000	0.000	0.000	0.000	0.000	0.066	0.000	0.250	0.000	0.0
17.5	0		0.000	0.000	0.000	0.000	0.000	0.000	0.000	0.250	0.000	0.0
18	0		0.000	0.000	0.000	0.000	0.000	0.000	0.000	0.250	0.000	0.0

Total Excess Volume for Storage = 150.5 m³

C192 - Hong Kong & Kowloon Timber Merchants Association Yard at Lin Ma Hang Road

Hydrographs and Storage - Sites C, D and E

30-Minute Duration

Hydrographs and Storage Volumes based on full hydrographs using storm profiles from the DSD SDM 5th Edition
(Refer to SDM Table 5d - Storm Profile for North District and Figure 6)

Assume Site Areas are equally divided over the time of Concentration, i.e. $t_c = 6$ minutes, so 1/6 of the Site over each minute

	(m ²)	C Value	Average C
Site Area	15,232		0.810
Paved	11,389	1.00	
Unpaved	104	0.20	
Local Catchments	2,649	0.35	

Case 2 - 30-minute duration, 1 in 10-year

Time (min)	Rainfall Intensity (mm/hr)	Area m ² = C =	Area 1 2538.7 0.810 Runoff (m ³ /s)	Area 2 2538.7 0.810 Runoff (m ³ /s)	Area 3 2538.7 0.810 Runoff (m ³ /s)	Area 4 2538.7 0.810 Runoff (m ³ /s)	Area 5 2538.7 0.810 Runoff (m ³ /s)	Area 6 2538.7 0.810 Runoff (m ³ /s)	Overall Runoff Hydrograph (m ³ /s)	Original Peak Discharge (m ³ /s)	Excess Discharge (m ³ /s)	Excess Volume in Time Period (m ³)
0	0		0.000	0.000	0.000	0.000	0.000	0.000	0.000	0.250	0.000	0.0
0.5	72		0.041	0.000	0.000	0.000	0.000	0.000	0.041	0.250	0.000	0.0
1	75		0.043	0.000	0.000	0.000	0.000	0.000	0.043	0.250	0.000	0.0
1.5	75		0.043	0.041	0.000	0.000	0.000	0.000	0.084	0.250	0.000	0.0
2	78		0.045	0.043	0.000	0.000	0.000	0.000	0.087	0.250	0.000	0.0
2.5	78		0.045	0.043	0.041	0.000	0.000	0.000	0.129	0.250	0.000	0.0
3	82		0.047	0.045	0.043	0.000	0.000	0.000	0.134	0.250	0.000	0.0
3.5	82		0.047	0.045	0.043	0.041	0.000	0.000	0.175	0.250	0.000	0.0
4	86		0.049	0.047	0.045	0.043	0.000	0.000	0.183	0.250	0.000	0.0
4.5	86		0.049	0.047	0.045	0.043	0.041	0.000	0.225	0.250	0.000	0.0
5	90		0.051	0.049	0.047	0.045	0.043	0.000	0.235	0.250	0.000	0.0
5.5	90		0.051	0.049	0.047	0.045	0.043	0.041	0.276	0.250	0.026	0.8
6	95		0.054	0.051	0.049	0.047	0.045	0.043	0.289	0.250	0.039	1.2
6.5	95		0.054	0.051	0.049	0.047	0.045	0.043	0.289	0.250	0.039	1.2
7	101		0.058	0.054	0.051	0.049	0.047	0.045	0.304	0.250	0.054	1.6
7.5	101		0.058	0.054	0.051	0.049	0.047	0.045	0.304	0.250	0.054	1.6
8	107		0.061	0.058	0.054	0.051	0.049	0.047	0.321	0.250	0.071	2.1
8.5	107		0.061	0.058	0.054	0.051	0.049	0.047	0.321	0.250	0.071	2.1
9	115		0.066	0.061	0.058	0.054	0.051	0.049	0.340	0.250	0.090	2.7
9.5	115		0.066	0.061	0.058	0.054	0.051	0.049	0.340	0.250	0.090	2.7
10	123		0.070	0.066	0.061	0.058	0.054	0.051	0.361	0.250	0.111	3.3
10.5	123		0.070	0.066	0.061	0.058	0.054	0.051	0.361	0.250	0.111	3.3
11	133		0.076	0.070	0.066	0.061	0.058	0.054	0.385	0.250	0.135	4.1
11.5	133		0.076	0.070	0.066	0.061	0.058	0.054	0.385	0.250	0.135	4.1
12	145		0.083	0.076	0.070	0.066	0.061	0.058	0.414	0.250	0.164	4.9
12.5	145		0.083	0.076	0.070	0.066	0.061	0.058	0.414	0.250	0.164	4.9
13	160		0.091	0.083	0.076	0.070	0.066	0.061	0.448	0.250	0.198	5.9
13.5	160		0.091	0.083	0.076	0.070	0.066	0.061	0.448	0.250	0.198	5.9
14	177		0.101	0.091	0.083	0.076	0.070	0.066	0.488	0.250	0.238	7.1
14.5	177		0.101	0.091	0.083	0.076	0.070	0.066	0.488	0.250	0.238	7.1
15	193		0.110	0.101	0.091	0.083	0.076	0.070	0.532	0.250	0.282	8.5
15.5	193		0.110	0.101	0.091	0.083	0.076	0.070	0.532	0.250	0.282	8.5
16	177		0.101	0.110	0.101	0.091	0.083	0.076	0.563	0.250	0.313	9.4
16.5	177		0.101	0.110	0.101	0.091	0.083	0.076	0.563	0.250	0.313	9.4
17	160		0.091	0.101	0.110	0.101	0.091	0.083	0.578	0.250	0.328	9.9
17.5	160		0.091	0.101	0.110	0.101	0.091	0.083	0.578	0.250	0.328	9.9
18	145		0.083	0.091	0.101	0.110	0.101	0.091	0.578	0.250	0.328	9.9
18.5	145		0.083	0.091	0.101	0.110	0.101	0.091	0.578	0.250	0.328	9.9
19	133		0.076	0.083	0.091	0.101	0.110	0.101	0.563	0.250	0.313	9.4
19.5	133		0.076	0.083	0.091	0.101	0.110	0.101	0.563	0.250	0.313	9.4
20	123		0.070	0.076	0.083	0.091	0.101	0.110	0.532	0.250	0.282	8.5
20.5	123		0.070	0.076	0.083	0.091	0.101	0.110	0.532	0.250	0.282	8.5
21	115		0.066	0.070	0.076	0.083	0.091	0.101	0.488	0.250	0.238	7.1
21.5	115		0.066	0.070	0.076	0.083	0.091	0.101	0.488	0.250	0.238	7.1
22	107		0.061	0.066	0.070	0.076	0.083	0.091	0.448	0.250	0.198	5.9
22.5	107		0.061	0.066	0.070	0.076	0.083	0.091	0.448	0.250	0.198	5.9
23	101		0.058	0.061	0.066	0.070	0.076	0.083	0.414	0.250	0.164	4.9
23.5	101		0.058	0.061	0.066	0.070	0.076	0.083	0.414	0.250	0.164	4.9
24	95		0.054	0.058	0.061	0.066	0.070	0.076	0.385	0.250	0.135	4.1
24.5	95		0.054	0.058	0.061	0.066	0.070	0.076	0.385	0.250	0.135	4.1
25	90		0.051	0.054	0.058	0.061	0.066	0.070	0.361	0.250	0.111	3.3
25.5	90		0.051	0.054	0.058	0.061	0.066	0.070	0.361	0.250	0.111	3.3
26	86		0.049	0.051	0.054	0.058	0.061	0.066	0.340	0.250	0.090	2.7
26.5	86		0.049	0.051	0.054	0.058	0.061	0.066	0.340	0.250	0.090	2.7
27	82		0.047	0.049	0.051	0.054	0.058	0.061	0.321	0.250	0.071	2.1
27.5	82		0.047	0.049	0.051	0.054	0.058	0.061	0.321	0.250	0.071	2.1
28	78		0.045	0.047	0.049	0.051	0.054	0.058	0.304	0.250	0.054	1.6
28.5	78		0.045	0.047	0.049	0.051	0.054	0.058	0.304	0.250	0.054	1.6
29	75		0.043	0.045	0.047	0.049	0.051	0.054	0.289	0.250	0.039	1.2
29.5	75		0.043	0.045	0.047	0.049	0.051	0.054	0.289	0.250	0.039	1.2
30	72		0.041	0.043	0.045	0.047	0.049	0.051	0.276	0.250	0.026	0.8
30.5	0		0.000	0.043	0.045	0.047	0.049	0.051	0.235	0.250	0.000	0.0
31	0		0.000	0.041	0.043	0.045	0.047	0.049	0.225	0.250	0.000	0.0
31.5	0		0.000	0.000	0.043	0.045	0.047	0.049	0.183	0.250	0.000	0.0
32	0		0.000	0.000	0.041	0.043	0.045	0.047	0.175	0.250	0.000	0.0
32.5	0		0.000	0.000	0.000	0.043	0.045	0.047	0.134	0.250	0.000	0.0
33	0		0.000	0.000	0.000	0.041	0.043	0.045	0.129	0.250	0.000	0.0
33.5	0		0.000	0.000	0.000	0.000	0.043	0.045	0.087	0.250	0.000	0.0
34	0		0.000	0.000	0.000	0.000	0.041	0.043	0.084	0.250	0.000	0.0
34.5	0		0.000	0.000	0.000	0.000	0.000	0.043	0.043	0.250	0.000	0.0
35	0		0.000	0.000	0.000	0.000	0.000	0.041	0.041	0.250	0.000	0.0
35.5	0		0.000	0.000	0.000	0.000	0.000	0.000	0.000	0.250	0.000	0.0
36	0		0.000	0.000	0.000	0.000	0.000	0.000	0.000	0.250	0.000	0.0

Total Excess Volume for Storage = 244.2 m³

C192 - Hong Kong & Kowloon Timber Merchants Association Yard at Lin Ma Hang Road
Hydrographs and Storage - Sites C, D and E
60-Minute Duration

Hydrographs and Storage Volumes based on full hydrographs using storm profiles from the DSD SDM 5th Edition
(Refer to SDM Table 5d - Storm Profile for North District and Figure 6)

Assume Site Areas are equally divided over the time of Concentration, i.e. $t_c = 6$ minutes, so 1/6 of the Site over each minute

	(m ²)	C Value	Average C
Site Area	15,232		0.810
Paved	11,389	1.00	
Unpaved	104	0.20	
Local Catchm	2,649	0.35	

Case 3 - 60-minute duration, 1 in 10-year

Time	Rainfall Intensity	Area m ² = C ×	Area 1 2538.7 0.810	Area 2 2538.7 0.810	Area 3 2538.7 0.810	Area 4 2538.7 0.810	Area 5 2538.7 0.810	Area 6 2538.7 0.810	Overall Runoff Hydrograph	Original Peak Discharge	Excess Discharge	Excess Volume in Time Period
(min)	(mm/hr)		Runoff (m ³ /s)	Runoff (m ³ /s)	Runoff (m ³ /s)	Runoff (m ³ /s)	Runoff (m ³ /s)	Runoff (m ³ /s)	(m ³ /s)	(m ³ /s)	(m ³ /s)	(m ³)
0	0		0.000	0.000	0.000	0.000	0.000	0.000	0.000	0.250	0.000	0.0
0.5	47		0.027	0.000	0.000	0.000	0.000	0.000	0.027	0.250	0.000	0.0
1	48		0.027	0.000	0.000	0.000	0.000	0.000	0.027	0.250	0.000	0.0
1.5	48		0.028	0.027	0.000	0.000	0.000	0.000	0.054	0.250	0.000	0.0
2	49		0.028	0.027	0.000	0.000	0.000	0.000	0.055	0.250	0.000	0.0
2.5	49		0.028	0.027	0.000	0.000	0.000	0.000	0.052	0.250	0.000	0.0
3	50		0.029	0.028	0.027	0.000	0.000	0.000	0.084	0.250	0.000	0.0
3.5	50		0.029	0.028	0.027	0.027	0.000	0.000	0.111	0.250	0.000	0.0
4	51		0.029	0.029	0.028	0.027	0.000	0.000	0.113	0.250	0.000	0.0
4.5	51		0.029	0.029	0.028	0.027	0.000	0.000	0.140	0.250	0.000	0.0
5	52		0.030	0.029	0.029	0.028	0.027	0.000	0.143	0.250	0.000	0.0
5.5	52		0.030	0.029	0.029	0.028	0.027	0.027	0.170	0.250	0.000	0.0
6	54		0.031	0.030	0.029	0.029	0.028	0.027	0.174	0.250	0.000	0.0
6.5	54		0.031	0.030	0.029	0.029	0.028	0.027	0.174	0.250	0.000	0.0
7	55		0.031	0.031	0.030	0.029	0.029	0.028	0.178	0.250	0.000	0.0
7.5	55		0.031	0.031	0.030	0.029	0.029	0.028	0.178	0.250	0.000	0.0
8	57		0.033	0.031	0.031	0.030	0.029	0.029	0.182	0.250	0.000	0.0
8.5	57		0.033	0.031	0.031	0.030	0.029	0.029	0.182	0.250	0.000	0.0
9	59		0.034	0.033	0.031	0.031	0.030	0.029	0.187	0.250	0.000	0.0
9.5	59		0.034	0.033	0.031	0.031	0.030	0.029	0.187	0.250	0.000	0.0
10	60		0.034	0.034	0.033	0.031	0.031	0.030	0.193	0.250	0.000	0.0
10.5	60		0.034	0.034	0.033	0.031	0.031	0.030	0.193	0.250	0.000	0.0
11	62		0.035	0.034	0.034	0.033	0.031	0.031	0.198	0.250	0.000	0.0
11.5	62		0.035	0.034	0.034	0.033	0.031	0.031	0.198	0.250	0.000	0.0
12	64		0.037	0.035	0.034	0.034	0.033	0.031	0.204	0.250	0.000	0.0
12.5	64		0.037	0.035	0.034	0.034	0.033	0.031	0.204	0.250	0.000	0.0
13	67		0.038	0.037	0.035	0.034	0.033	0.033	0.211	0.250	0.000	0.0
13.5	67		0.038	0.037	0.035	0.034	0.033	0.033	0.211	0.250	0.000	0.0
14	69		0.039	0.038	0.037	0.036	0.034	0.034	0.218	0.250	0.000	0.0
14.5	69		0.039	0.038	0.037	0.036	0.034	0.034	0.218	0.250	0.000	0.0
15	72		0.041	0.039	0.038	0.037	0.035	0.034	0.225	0.250	0.000	0.0
15.5	72		0.041	0.039	0.038	0.037	0.035	0.034	0.225	0.250	0.000	0.0
16	75		0.043	0.041	0.039	0.038	0.037	0.035	0.234	0.250	0.000	0.0
16.5	75		0.043	0.041	0.039	0.038	0.037	0.035	0.234	0.250	0.000	0.0
17	78		0.045	0.043	0.041	0.039	0.038	0.037	0.243	0.250	0.000	0.0
17.5	78		0.045	0.043	0.041	0.039	0.038	0.037	0.243	0.250	0.000	0.0
18	82		0.047	0.045	0.043	0.041	0.039	0.038	0.253	0.250	0.003	0.1
18.5	82		0.047	0.045	0.043	0.041	0.039	0.038	0.253	0.250	0.003	0.1
19	86		0.049	0.047	0.045	0.043	0.041	0.039	0.264	0.250	0.014	0.4
19.5	86		0.049	0.047	0.045	0.043	0.041	0.039	0.264	0.250	0.014	0.4
20	90		0.051	0.049	0.047	0.045	0.043	0.041	0.276	0.250	0.026	0.8
20.5	90		0.051	0.049	0.047	0.045	0.043	0.041	0.276	0.250	0.026	0.8
21	95		0.054	0.051	0.049	0.047	0.045	0.043	0.289	0.250	0.039	1.2
21.5	95		0.054	0.051	0.049	0.047	0.045	0.043	0.289	0.250	0.039	1.2
22	101		0.058	0.054	0.051	0.049	0.047	0.045	0.304	0.250	0.054	1.6
22.5	101		0.058	0.054	0.051	0.049	0.047	0.045	0.304	0.250	0.054	1.6
23	107		0.061	0.058	0.056	0.054	0.051	0.049	0.321	0.250	0.071	2.1
23.5	107		0.061	0.058	0.056	0.054	0.051	0.049	0.321	0.250	0.071	2.1
24	115		0.066	0.061	0.058	0.056	0.054	0.051	0.340	0.250	0.090	2.7
24.5	115		0.066	0.061	0.058	0.056	0.054	0.051	0.340	0.250	0.090	2.7
25	123		0.070	0.066	0.061	0.058	0.056	0.054	0.361	0.250	0.111	3.3
25.5	123		0.070	0.066	0.061	0.058	0.056	0.054	0.361	0.250	0.111	3.3
26	133		0.076	0.070	0.066	0.061	0.058	0.056	0.385	0.250	0.135	4.1
26.5	133		0.076	0.070	0.066	0.061	0.058	0.056	0.385	0.250	0.135	4.1
27	145		0.083	0.076	0.070	0.066	0.061	0.058	0.414	0.250	0.164	4.9
27.5	145		0.083	0.076	0.070	0.066	0.061	0.058	0.414	0.250	0.164	4.9
28	160		0.091	0.083	0.076	0.070	0.066	0.061	0.448	0.250	0.198	5.9
28.5	160		0.091	0.083	0.076	0.070	0.066	0.061	0.448	0.250	0.198	5.9
29	177		0.091	0.083	0.076	0.070	0.066	0.061	0.488	0.250	0.238	7.1
29.5	177		0.091	0.083	0.076	0.070	0.066	0.061	0.488	0.250	0.238	7.1
30	193		0.110	0.101	0.091	0.083	0.076	0.070	0.532	0.250	0.282	8.5
30.5	193		0.110	0.101	0.091	0.083	0.076	0.070	0.532	0.250	0.282	8.5
31	177		0.110	0.101	0.091	0.083	0.076	0.070	0.563	0.250	0.313	9.4
31.5	177		0.110	0.101	0.091	0.083	0.076	0.070	0.563	0.250	0.313	9.4
32	160		0.091	0.101	0.110	0.101	0.091	0.083	0.578	0.250	0.328	9.9
32.5	160		0.091	0.101	0.110	0.101	0.091	0.083	0.578	0.250	0.328	9.9
33	145		0.083	0.091	0.101	0.110	0.101	0.091	0.578	0.250	0.328	9.9
33.5	145		0.083	0.091	0.101	0.110	0.101	0.091	0.578	0.250	0.328	9.9
34	133		0.076	0.083	0.091	0.101	0.110	0.101	0.563	0.250	0.313	9.4
34.5	133		0.076	0.083	0.091	0.101	0.110	0.101	0.563	0.250	0.313	9.4
35	123		0.070	0.076	0.083	0.091	0.101	0.110	0.532	0.250	0.282	8.5
35.5	123		0.070	0.076	0.083	0.091	0.101	0.110	0.532	0.250	0.282	8.5
36	115		0.066	0.070	0.076	0.083	0.091	0.101	0.488	0.250	0.238	7.1
36.5	115		0.066	0.070	0.076	0.083	0.091	0.101	0.488	0.250	0.238	7.1
37	107		0.061	0.066	0.070	0.076	0.083	0.091	0.448	0.250	0.198	5.9
37.5	107		0.061	0.066	0.070	0.076	0.083	0.091	0.448	0.250	0.198	5.9
38	101		0.058	0.061	0.066	0.070	0.076	0.083	0.414	0.250	0.164	4.9
38.5	101		0.058	0.061	0.066	0.070	0.076	0.083	0.414	0.250	0.164	4.9
39	95		0.054	0.058	0.061	0.066	0.070	0.076	0.385	0.250	0.135	4.1
39.5	95		0.054	0.058	0.061	0.066	0.070	0.076	0.385	0.250	0.135	4.1
40	90		0.051	0.054	0.058	0.061	0.066	0.070	0.361	0.250	0.111	3.3
40.5	90		0.051	0.054	0.058	0.061	0.066	0.070	0.361	0.250	0.111	3.3
41	86		0.049	0.051	0.054	0.058	0.061	0.066	0.340	0.250	0.090	2.7
41.5	86		0.049	0.051	0.054	0.058	0.061	0.066	0.340	0.250	0.090	2.7
42	82		0.047	0.049	0.051	0.054	0.058	0.061	0.321	0.250	0.071	2.1
42.5	82		0.047	0.049	0.051	0.054	0.058	0.061	0.321	0.250	0.071	2.1
43	78		0.045	0.047	0.049	0.051	0.054	0.058	0.304	0.250	0.054	1.6
43.5	78		0.045	0.047	0.049	0.051	0.054	0.058	0.304	0.250	0.054	1.6
44	75		0.043	0.045	0.047	0.049	0.051	0.054	0.289	0.250	0.039	1.2
44.5	75		0.043	0.045	0.047	0.049	0.051	0.054	0.289	0.250	0.039	1.2
45	72		0.041	0.043	0.045	0.047	0.049	0.051	0.276	0.250	0.026	0.8
45.5	72		0.041	0.043	0.045	0.047	0.049	0.051	0.276	0.250	0.026	0.8
46	69		0.039	0.041	0.043	0.045	0.047	0.049	0.264	0.250	0.014	0.4
46.5	69											

C192 - Hong Kong & Kowloon Timber Merchants Association Yard at Lin Ma Hang Road
 Hydrographs and Storage - Sites C, D and E
 30 Minute Duration

Hydrographs and Storage Volumes based on full hydrographs using storm profiles from the DSD SCM 5th Edition
 (Refer to SCM Table 5.7 - Storm Profile for North District and Figure 6)

Assume Site Areas are equally divided over the time of Concentration, i.e. t_c = 6 minutes, so 1/6 of the Site over each minute

Site Area	15,232	0.810
Peak	11.389	1.00
Unpeaked	104	0.30
Local Catchment	2,649	0.35

Table 3 - 30 Minute Duration, t_c = 6 min

Time (min)	Rainfall Intensity (mm/hr)	Area (m ²)	Area 1 (m ²)	Area 2 (m ²)	Area 3 (m ²)	Area 4 (m ²)	Area 5 (m ²)	Area 6 (m ²)	Outlet Runoff (m ³ /s)	Original Hydrograph (m ³ /s)	Excess Discharge (m ³ /s)	Excess Volume in Time (m ³)
(min)	(mm/hr)	C =	2538.7 0.810	2538.7 0.810	2538.7 0.810	2538.7 0.810	2538.7 0.810	2538.7 0.810	Runoff (m ³ /s)	Hydrograph	Discharge	Peak
0	0	0.000	0.000	0.000	0.000	0.000	0.000	0.000	0.000	0.250	0.000	0.0
0.5	36	0.021	0.000	0.000	0.000	0.000	0.000	0.000	0.021	0.250	0.000	0.0
1	36	0.021	0.000	0.000	0.000	0.000	0.000	0.000	0.021	0.250	0.000	0.0
1.5	36	0.021	0.021	0.000	0.000	0.000	0.000	0.000	0.041	0.250	0.000	0.0
2	37	0.021	0.021	0.000	0.000	0.000	0.000	0.000	0.042	0.250	0.000	0.0
2.5	37	0.021	0.021	0.021	0.000	0.000	0.000	0.000	0.062	0.250	0.000	0.0
3	37	0.021	0.021	0.021	0.000	0.000	0.000	0.000	0.063	0.250	0.000	0.0
3.5	37	0.021	0.021	0.021	0.021	0.000	0.000	0.000	0.083	0.250	0.000	0.0
4	38	0.022	0.021	0.021	0.021	0.000	0.000	0.000	0.085	0.250	0.000	0.0
4.5	38	0.022	0.021	0.021	0.021	0.021	0.000	0.000	0.105	0.250	0.000	0.0
5	39	0.022	0.021	0.021	0.021	0.021	0.021	0.000	0.107	0.250	0.000	0.0
5.5	39	0.022	0.022	0.021	0.021	0.021	0.021	0.021	0.127	0.250	0.000	0.0
6	39	0.022	0.022	0.022	0.021	0.021	0.021	0.021	0.129	0.250	0.000	0.0
6.5	39	0.022	0.022	0.022	0.021	0.021	0.021	0.021	0.129	0.250	0.000	0.0
7	40	0.023	0.022	0.022	0.022	0.021	0.021	0.021	0.131	0.250	0.000	0.0
7.5	40	0.023	0.022	0.022	0.022	0.022	0.021	0.021	0.131	0.250	0.000	0.0
8	41	0.023	0.023	0.022	0.022	0.022	0.022	0.021	0.134	0.250	0.000	0.0
8.5	41	0.023	0.023	0.022	0.022	0.022	0.022	0.021	0.134	0.250	0.000	0.0
9	41	0.023	0.023	0.023	0.022	0.022	0.022	0.022	0.136	0.250	0.000	0.0
9.5	41	0.023	0.023	0.023	0.022	0.022	0.022	0.022	0.136	0.250	0.000	0.0
10	42	0.024	0.023	0.023	0.023	0.022	0.022	0.022	0.138	0.250	0.000	0.0
10.5	42	0.024	0.023	0.023	0.023	0.022	0.022	0.022	0.138	0.250	0.000	0.0
11	43	0.025	0.024	0.023	0.023	0.023	0.022	0.022	0.141	0.250	0.000	0.0
11.5	43	0.025	0.024	0.023	0.023	0.023	0.022	0.022	0.141	0.250	0.000	0.0
12	44	0.025	0.025	0.024	0.023	0.023	0.023	0.023	0.143	0.250	0.000	0.0
12.5	44	0.025	0.025	0.024	0.023	0.023	0.023	0.023	0.143	0.250	0.000	0.0
13	45	0.026	0.025	0.025	0.024	0.023	0.023	0.023	0.146	0.250	0.000	0.0
13.5	45	0.026	0.025	0.025	0.024	0.023	0.023	0.023	0.146	0.250	0.000	0.0
14	46	0.026	0.026	0.025	0.024	0.023	0.023	0.023	0.149	0.250	0.000	0.0
14.5	46	0.026	0.026	0.025	0.025	0.024	0.023	0.023	0.149	0.250	0.000	0.0
15	47	0.027	0.026	0.025	0.025	0.024	0.023	0.023	0.153	0.250	0.000	0.0
15.5	47	0.027	0.026	0.026	0.025	0.025	0.024	0.023	0.153	0.250	0.000	0.0
16	48	0.027	0.026	0.026	0.026	0.025	0.025	0.025	0.156	0.250	0.000	0.0
16.5	48	0.027	0.027	0.026	0.026	0.026	0.025	0.025	0.159	0.250	0.000	0.0
17	49	0.028	0.027	0.027	0.026	0.026	0.026	0.025	0.159	0.250	0.000	0.0
17.5	49	0.028	0.027	0.027	0.026	0.026	0.026	0.025	0.159	0.250	0.000	0.0
18	50	0.029	0.028	0.027	0.027	0.026	0.026	0.026	0.163	0.250	0.000	0.0
18.5	50	0.029	0.028	0.028	0.027	0.027	0.026	0.026	0.166	0.250	0.000	0.0
19	51	0.029	0.029	0.028	0.027	0.027	0.026	0.026	0.166	0.250	0.000	0.0
19.5	51	0.029	0.029	0.029	0.028	0.027	0.027	0.027	0.170	0.250	0.000	0.0
20	52	0.030	0.029	0.029	0.028	0.027	0.027	0.027	0.170	0.250	0.000	0.0
20.5	52	0.030	0.029	0.029	0.028	0.027	0.027	0.027	0.170	0.250	0.000	0.0
21	54	0.031	0.030	0.029	0.029	0.028	0.027	0.027	0.174	0.250	0.000	0.0
21.5	54	0.031	0.030	0.029	0.029	0.028	0.027	0.027	0.174	0.250	0.000	0.0
22	55	0.031	0.031	0.030	0.029	0.029	0.028	0.028	0.178	0.250	0.000	0.0
22.5	55	0.031	0.031	0.030	0.029	0.029	0.028	0.028	0.178	0.250	0.000	0.0
23	57	0.033	0.031	0.031	0.030	0.029	0.029	0.029	0.182	0.250	0.000	0.0
23.5	57	0.033	0.031	0.031	0.030	0.029	0.029	0.029	0.182	0.250	0.000	0.0
24	59	0.034	0.033	0.031	0.031	0.030	0.029	0.029	0.187	0.250	0.000	0.0
24.5	59	0.034	0.033	0.031	0.031	0.030	0.029	0.029	0.187	0.250	0.000	0.0
25	60	0.034	0.034	0.033	0.031	0.031	0.030	0.030	0.193	0.250	0.000	0.0
25.5	60	0.034	0.034	0.033	0.031	0.031	0.030	0.030	0.193	0.250	0.000	0.0
26	62	0.035	0.034	0.034	0.033	0.031	0.031	0.031	0.198	0.250	0.000	0.0
26.5	62	0.035	0.034	0.034	0.033	0.031	0.031	0.031	0.198	0.250	0.000	0.0
27	64	0.037	0.035	0.034	0.034	0.033	0.031	0.031	0.204	0.250	0.000	0.0
27.5	64	0.037	0.035	0.034	0.034	0.033	0.031	0.031	0.204	0.250	0.000	0.0
28	67	0.039	0.035	0.034	0.034	0.033	0.031	0.031	0.211	0.250	0.000	0.0
28.5	67	0.039	0.035	0.034	0.034	0.033	0.031	0.031	0.211	0.250	0.000	0.0
29	69	0.039	0.038	0.037	0.035	0.034	0.034	0.034	0.218	0.250	0.000	0.0
29.5	69	0.039	0.038	0.037	0.035	0.034	0.034	0.034	0.218	0.250	0.000	0.0
30	71	0.041	0.039	0.038	0.037	0.036	0.034	0.034	0.225	0.250	0.000	0.0
30.5	71	0.041	0.039	0.038	0.037	0.036	0.034	0.034	0.225	0.250	0.000	0.0
31	75	0.043	0.041	0.039	0.038	0.037	0.036	0.036	0.234	0.250	0.000	0.0
31.5	75	0.043	0.041	0.039	0.038	0.037	0.036	0.036	0.234	0.250	0.000	0.0
32	78	0.045	0.043	0.041	0.039	0.038	0.037	0.037	0.243	0.250	0.000	0.0
32.5	78	0.045	0.043	0.041	0.039	0.038	0.037	0.037	0.243	0.250	0.000	0.0
33	82	0.047	0.045	0.043	0.041	0.039	0.038	0.038	0.253	0.250	0.003	0.1
33.5	82	0.047	0.045	0.043	0.041	0.039	0.038	0.038	0.253	0.250	0.003	0.1
34	86	0.049	0.047	0.045	0.043	0.041	0.039	0.039	0.264	0.250	0.014	0.4
34.5	86	0.049	0.047	0.045	0.043	0.041	0.039	0.039	0.264	0.250	0.014	0.4
35	90	0.051	0.048	0.047	0.045	0.043	0.041	0.041	0.276	0.250	0.028	0.8
35.5	90	0.051	0.048	0.047	0.045	0.043	0.041	0.041	0.276	0.250	0.028	0.8
36	95	0.054	0.051	0.049	0.047	0.045	0.043	0.043	0.289	0.250	0.039	1.2
36.5	95	0.054	0.051	0.049	0.047	0.045	0.043	0.043	0.289	0.250	0.039	1.2
37	101	0.058	0.054	0.051	0.049	0.047	0.045	0.045	0.304	0.250	0.054	1.6
37.5	101	0.058	0.054	0.051	0.049	0.047	0.045	0.045	0.304	0.250	0.054	1.6
38	107	0.061	0.056	0.054	0.051	0.049	0.047	0.047	0.321	0.250	0.071	2.1
38.5	107	0.061	0.056	0.054	0.051	0.049	0.047	0.047	0.321	0.250	0.071	2.1
39	115	0.066	0.056	0.054	0.051	0.049	0.047	0.049	0.340	0.250	0.096	2.7
39.5	115	0.066	0.056	0.054	0.051	0.049	0.047	0.049	0.340	0.250	0.096	2.7
40	123	0.070	0.066	0.061	0.058	0.054	0.051	0.051	0.361	0.250	0.111	3.3
40.5	123	0.070	0.066	0.061	0.058	0.054	0.051	0.051	0.361	0.250	0.111	3.3
41	133	0.076	0.070	0.066	0.061	0.058	0.054	0.054	0.385	0.250	0.135	4.1
41.5	133	0.076	0.070	0.066	0.061	0.058	0.054	0.054	0.385	0.250	0.135	4.1
42	143	0.083	0.076	0.072	0.066	0.061	0.058	0.058	0.414	0.250	0.164	4.9
42.5	143	0.083	0.076	0.072	0.066	0.061	0.058	0.058	0.414	0.250	0.164	4.9
43	160	0.091	0.085	0.079	0.072	0.066	0.061	0.061	0.448	0.250	0.198	5.9
43.5	160	0.091	0.085	0.079	0.072	0.066	0.061	0.061	0.448	0.250	0.198	5.9
44	177	0.101	0.091	0.083	0.076	0.070	0.066	0.066	0.488	0.250	0.238	7.1
44.5	177	0.101	0.091	0.0								

Sites C, D & E 10-Minute Runoff Hydrograph

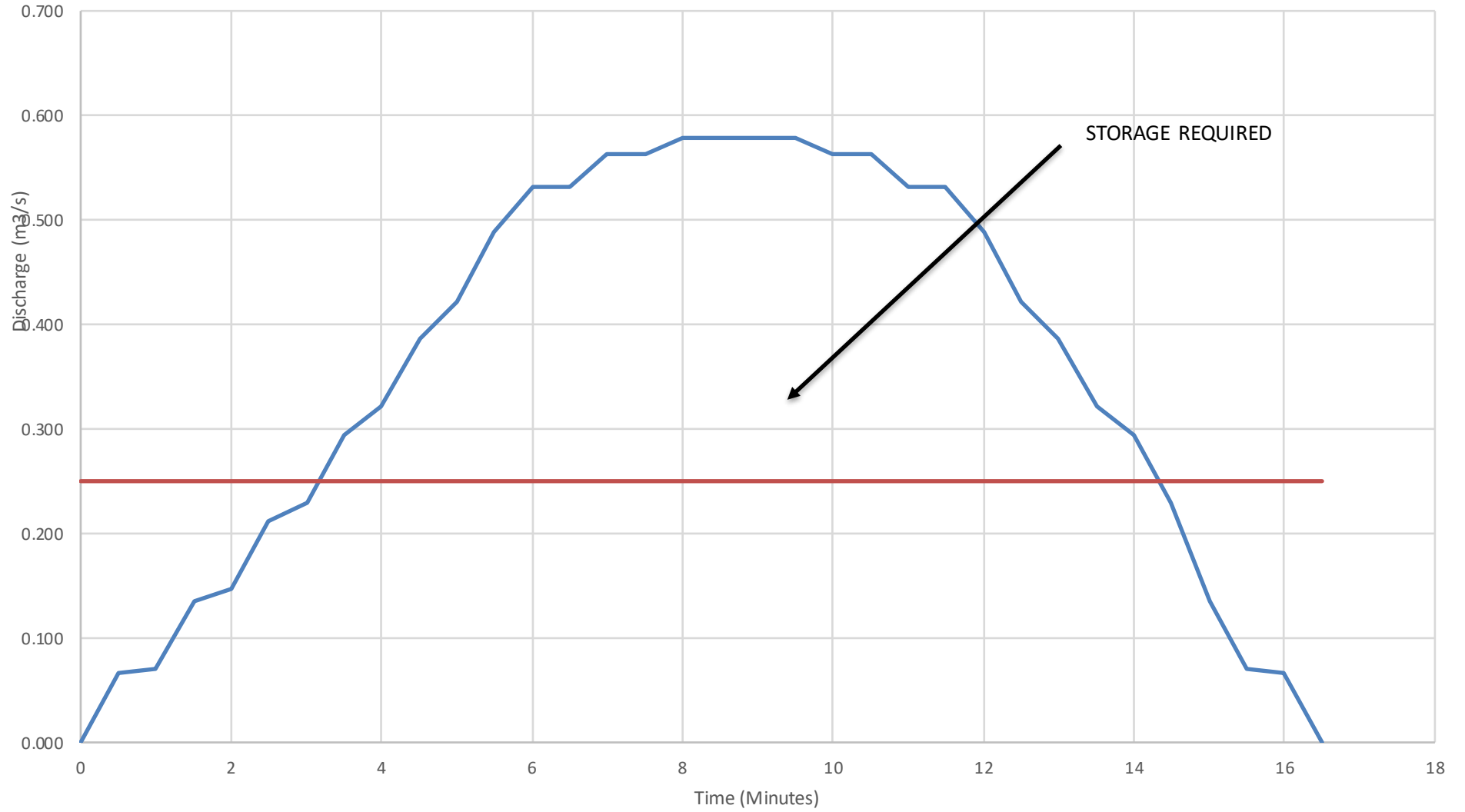

— Runoff Hydrograph — Original Peak Discharge

Sites C, D & E 30-Minute Runoff Hydrograph

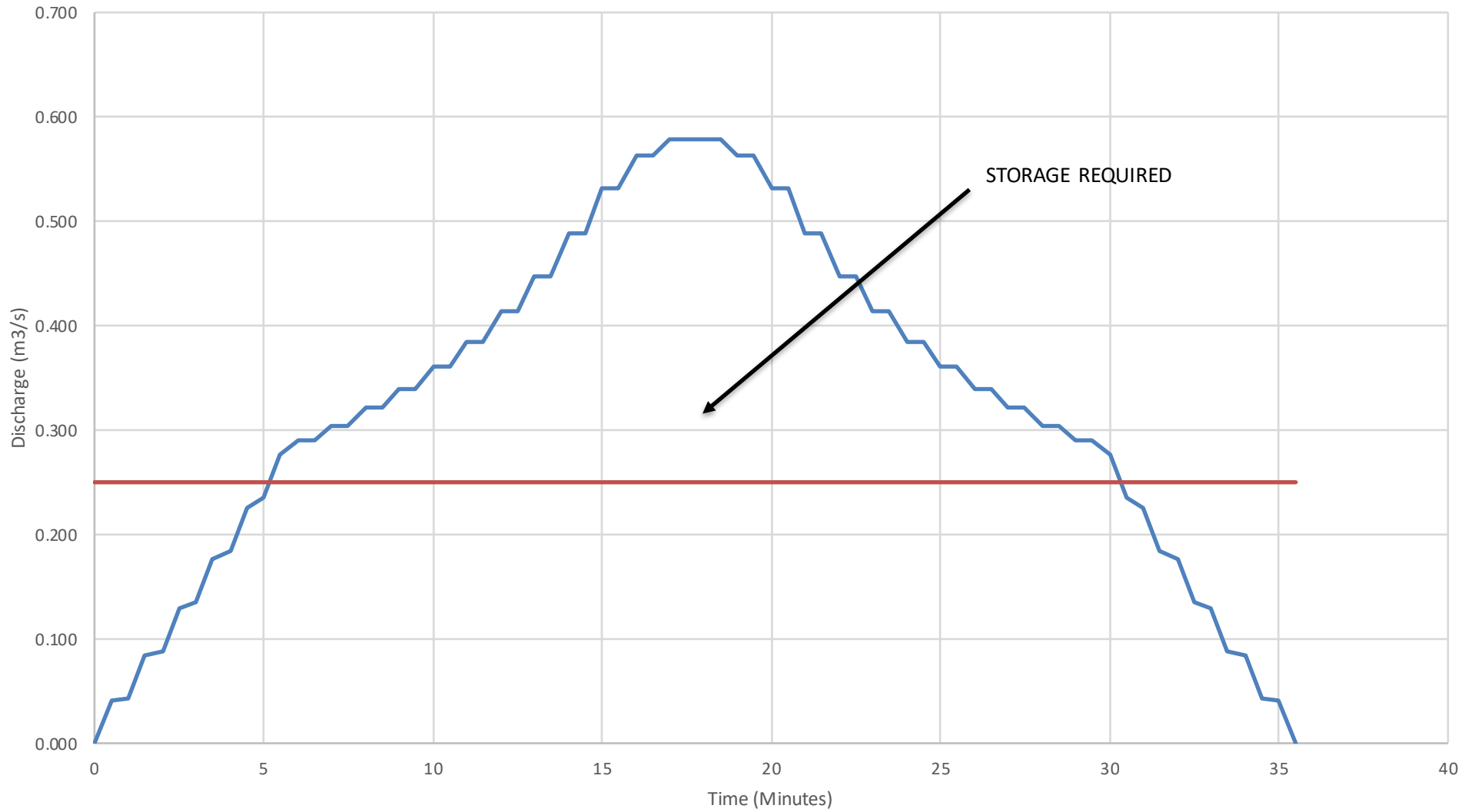

— Runoff Hydrograph — Original Peak Discharge

Sites C, D & E 60-Minute Runoff Hydrograph

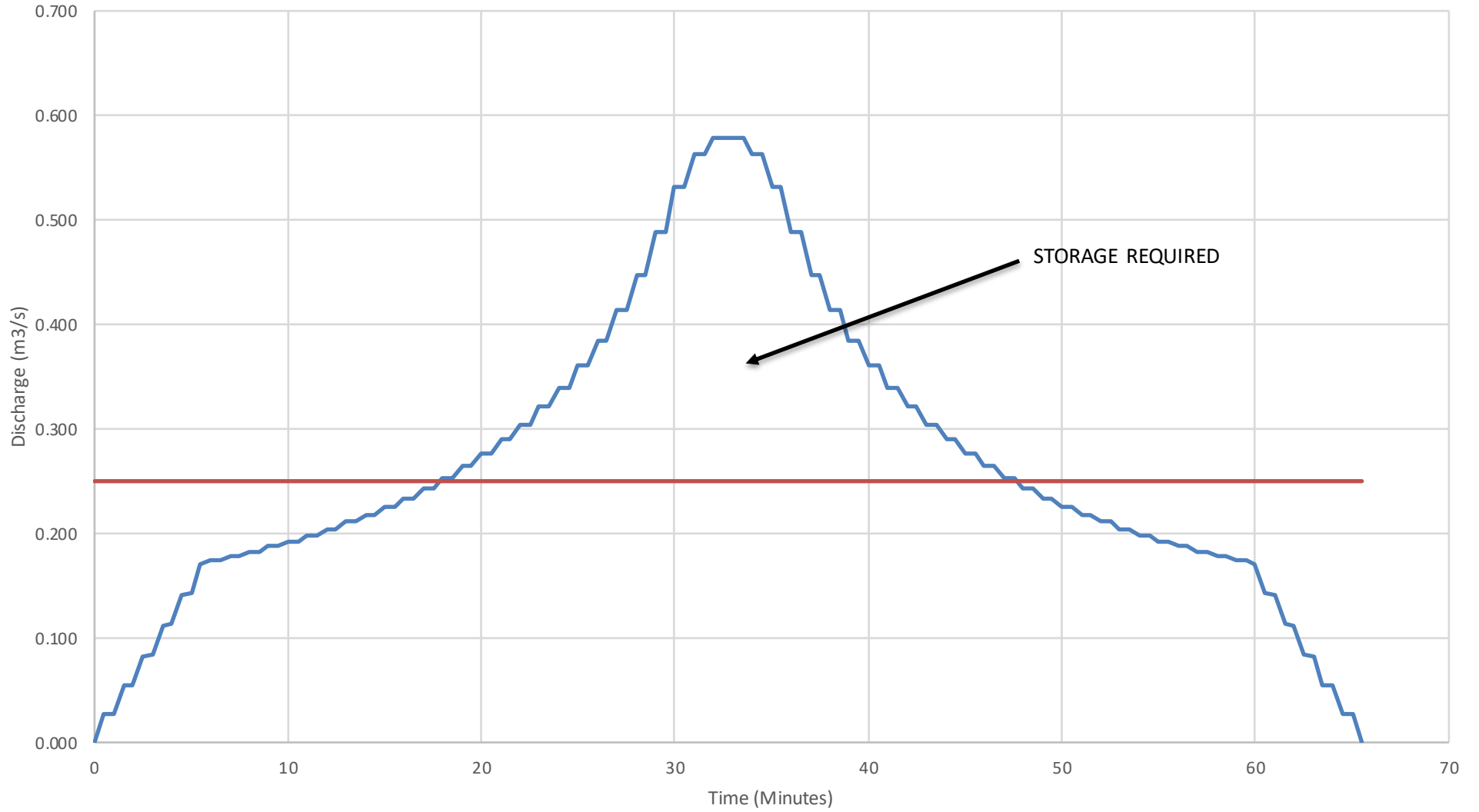

— Runoff Hydrograph — Original Peak Discharge

Sites C, D & E 60-Minute Runoff Hydrograph

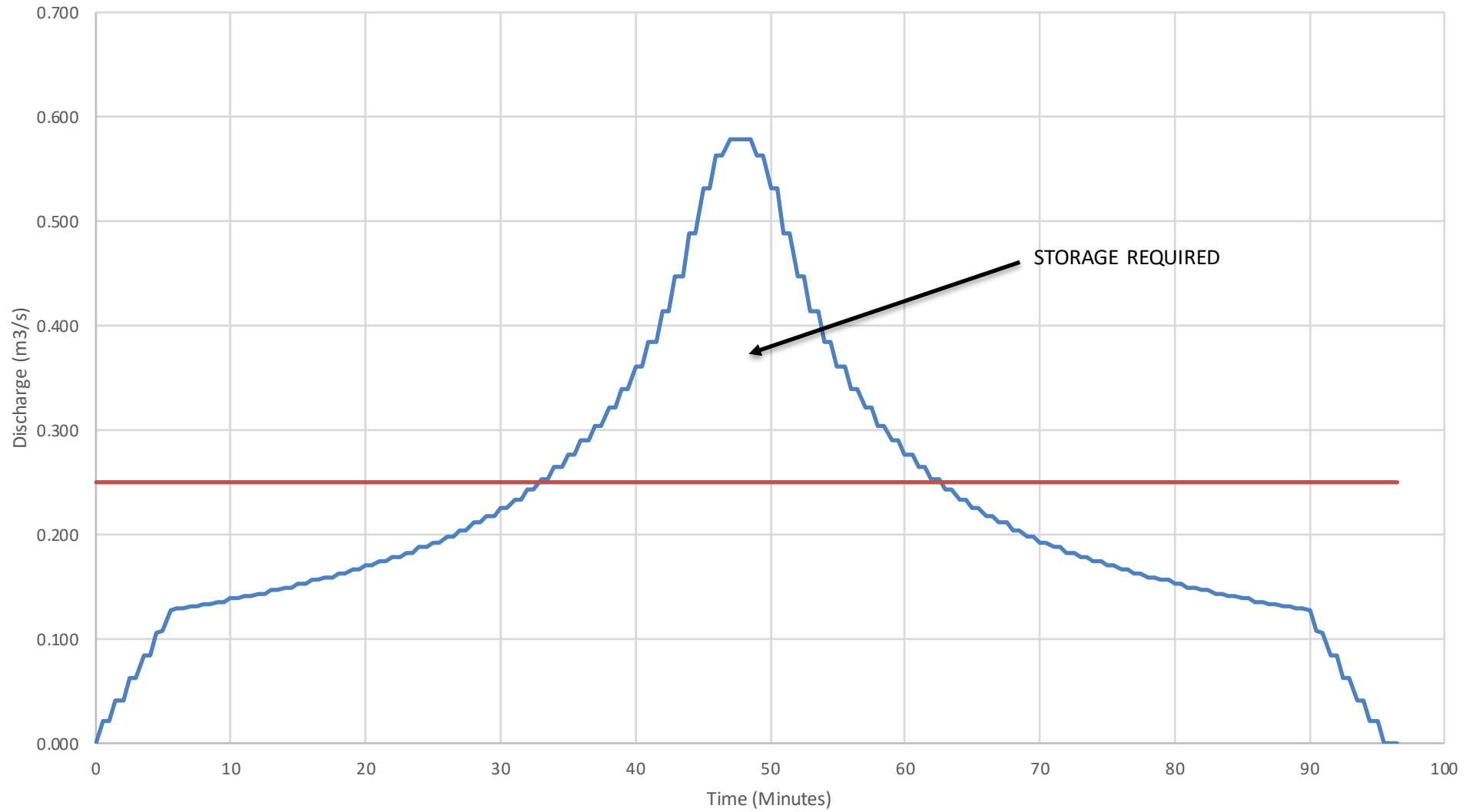

— Runoff Hydrograph — Original Peak Discharge

Appendix F

Stream Hydraulics

**C192 Hong Kong & Kowloon Timber Merchants Association Timber Yard at Lin Ma Hang Road
Existing East Channel
Capacity Check**

Assume:

1. Stream channel is rectangular
2. Dimensions from Initial Site Inspection (22/12/2023). Check worst location
3. Channel is existing concrete sides, with silt/soil base. Assume concrete lined channel, bad condition ($n = 0.018$)
4. Check capacity without freeboard

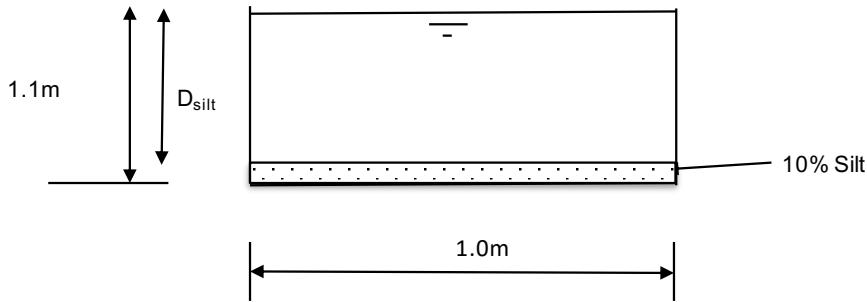

Gradient

Upstream IL =	N/A	mPD
Downstream IL =	N/A	mPD
Fall =	-	m

Distance between ILs = m

Overall channel gradient = 1/ 500 0.002 ASSUMED

Concrete Lined Channel, (bad condition); say, Manning's $n = 0.018$ (DSD SDM Table 13)

Without Freeboard Allowance

B = 1.00 m
 D = 1.10 m
 $D_{silt} = D \times 0.9 = 0.99$ m (allowing for 10% silt)

Top Width = 1.00 m

A (m^2) = 0.99 m^2

P (m) =
 1.00 m (base)
 1.98 m (side walls)
 2.98 m

R (m) = $A/P = 0.33$ m

Q (m^3/s) = $Av = A \times R^{2/3} \times S^{1/2} / n = 1.18$ m^3/s

v = 1.19 m/s

Appendix G

Prefabricated Drainage Units

Water tank information

Typical details of temporary storage tanks. Actual sizes to suit Site conditions and transportation limitations.

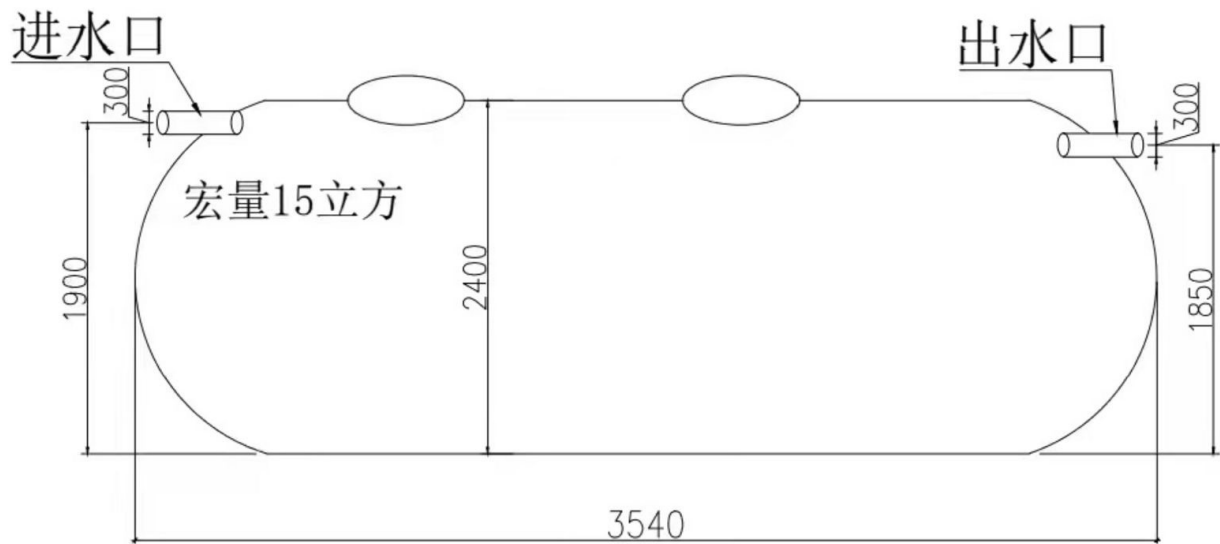

**C192 Hong Kong & Kowloon Timber Merchants Association
Timber Yard and Sawmill at Lin Ma Hang Road
Prefabricated Drainage Units**

It is proposed to generally use prefabricated units for the drainage facilities at the new Timber Yard and Sawmill. This will facilitate construction and help to ensure the quality of the final facilities. Typical images are shown below (subject to confirmation during construction).

Drainage Channels



Catchpits (Indicative only)



Appendix H

Overflow Weir Calculations

C192 Hong Kong & Kowloon Timber Merchants Association Timber Yard at Lin Ma Hang Road
Orifice/Sluice Discharges
Check Discharges

1. Assume orifice/sluice gate discharge for low flows
2. Weir overflow for excess flows
3. Discharge through Orifice/Sluice will increase as water level rises.

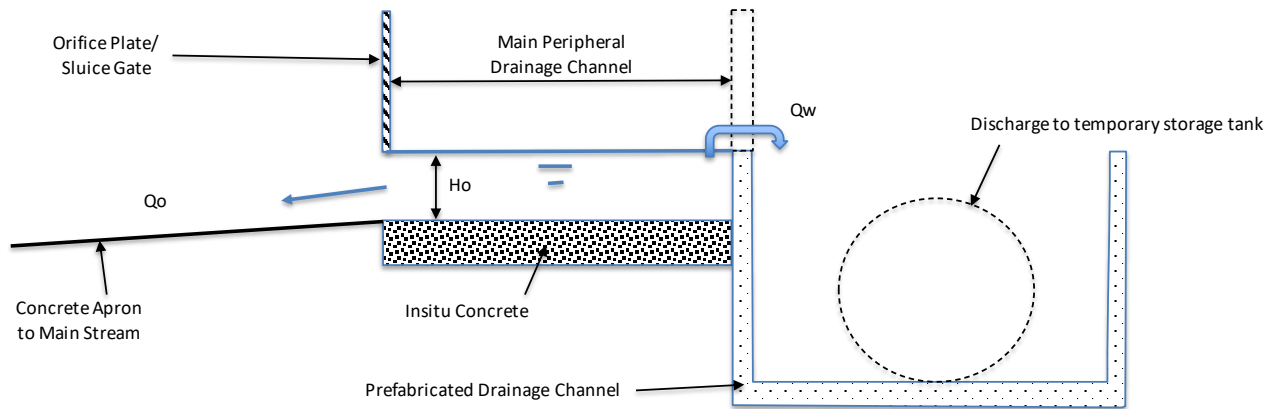

CROSS-SECTION THROUGH DISCHARGE/OVERFLOW CHAMBER

Sites A/B

Sites C/D/E

Flows

Existing/Proposed Discharge =	0.167 m ³ /s	0.250 m ³ /s
Future Flow =	0.432 m ³ /s	0.591 m ³ /s

Discharge Through Orifice/Sluice

Orifice Height, H_o =	0.110 m	0.160 m
Orifice Width =	1.0 m	1.0 m
Orifice/Sluice Discharge, $Q_o = C_d \times A \times (2gH)^{0.5}$		
Assume C_d =	0.6	0.6
Area, A =	0.11 m ²	0.160 m ²
Discharge, Q_o =	0.097 m³/s (< Existing Peak Discharge)	0.170 m³/s (< Proposed Peak Discharge)
(N.B. Maximum discharges before water level rises above the top of the orifice/sluice and over the weir)		
Weir Length, B =	3.0 m	4.0 m
Peak Excess Flow =	0.335 m ³ /s (to pass over weir)	0.421 m ³ /s (to pass over weir)

Overflow to Weir

Weir Discharge, $Q_w = C_w \times B \times H^{1.5}$		
$H_w = (Q_w / (C_w \times B))^{0.67}$		
Assume C_w =	1.5	1.5
Head over Weir, H_w =	0.175 m	0.169 m
Peak Q_o =	0.156 m³/s (<= Existing Peak Discharge)	0.244 m³/s (<= Proposed Peak Discharge)

Note: These are conservative assessments, as the water levels are based on the assumption that all excess flows pass over the weir.

Appendix I

Drainage Schedule

C192 - Hong Kong & Kowloon Timber Merchants Association Yard at Lin Ma Hang Road
 Drainage Schedule - Western Site

Refer to Site Catchment Plan (Figure 6), Overall Runoff Calculations and Standard Channel Capacity Calculations

Channel Section	Contributing Catchment(s)	Catchment Area (Cumulative) (m ²)	Runoff Coefficient	Rainfall Intensity [#] (mm/h)	Runoff (m ³ /s)	Minimum Gradient Required* (1 in)	Section Length (m)	Upstream		Downstream		Gradient Proposed (1 in)	Remarks
								Ground Level (mPD)	Invert Level (mPD)	Ground Level (mPD)	Invert Level (mPD)		
Site C													
Northern/Eastern Boundary													
P10-P09	C3 x 60%	1,085.4	0.35	169	0.018	350	44	14.0	13.7	12.5	12.2	29	Runoff from External Slopes
P09-P08	C3	1,809.0	0.35	169	0.030	350	26	12.5	12.2	11.8	11.5	37	Runoff from External Slopes
P08-P07	C3+C4	2,649.0	0.35	169	0.044	350	31	11.8	11.5	11.1	10.8	44	Runoff from External Slopes
P07-P06	C3+C4	2,649.0	0.35	169	0.044	350	22	11.1	10.8	10.8	10.5	73	Runoff from External Slopes
P06-P05	C3+C4	2,649.0	0.35	169	0.044	350	20	10.8	10.5	10.6	10.3	99	Runoff from External Slopes
P05-P04	C3+C4	2,649.0	0.35	169	0.044	350	33	10.6	10.3	10.2	9.9	82	Runoff from External Slopes
P04-P03	C3+C4	2,649.0	0.35	169	0.044	350	18	10.2	9.9	10.0	9.7	90	Runoff from External Slopes
P03-P02	C3+C4	2,649.0	0.35	169	0.044	350	20	10.0	9.7	9.7	9.4	67	Runoff from External Slopes
P02-P01	C3+C4	2,649.0	0.35	169	0.044	350	7	9.7	9.4	9.4	9.1	3	Drop section not using standard channels Outlet to Eastern Stream
Western/Southern Boundary													
P10-P11	Minor local runoff	0.0	1.00	169	0.000	350	20	14.0	13.7	13.4	13.1	33	
P11-P12	Minor local runoff	0.0	1.00	169	0.000	350	9	13.4	13.1	13.1	12.8	30	
P12-P13	Minor local runoff	0.0	1.00	169	0.000	350	3	13.1	12.8	12.9	12.6	15	
P13-P14	Minor local runoff	0.0	1.00	169	0.000	350	18	12.9	12.6	12.5	12.2	45	
P14-P15	Minor local runoff	0.0	1.00	169	0.000	350	8	12.5	12.2	12.2	11.9	27	
P15-P16	Minor local runoff	0.0	1.00	169	0.000	350	12	12.2	11.9	11.8	11.5	30	
P16-P17	Minor local runoff	0.0	1.00	169	0.000	350	5	11.8	11.5	11.6	11.3	25	
P17-P18	C1A x 25%	384.7	1.00	169	0.018	350	10	11.6	11.3	11.3	11.0	33	
P18-P19	C1A x 50%	769.3	1.00	169	0.036	350	15	11.3	11.0	10.8	10.5	30	
P19-P20	C1A x 75%	1,154.0	1.00	169	0.054	350	12	10.8	10.5	10.4	10.1	30	
P20-P21	C1A	1,538.6	1.00	169	0.072	350	13	10.4	10.1	10.0	9.7	33	
P21-P22	C1A	1,538.6	1.00	169	0.072	350	24	10.0	9.7	9.9	9.6	240	
P22-P23	C1A + C1B x 25%	1,721.8	1.00	169	0.081	350	20	9.9	9.6	9.8	9.5	200	
P23-P24	C1A + C1B x 50%	1,904.9	1.00	169	0.089	350	21	9.8	9.5	9.7	9.4	210	
P24-P25	C1A + C1B x 75%	2,088.1	1.00	169	0.098	350	17	9.7	9.4	9.6	9.3	170	
Southern Boundary													
P25-P26	C1A + C1B	2,271.3	1.00	169	0.107	350	30	9.6	9.3	9.45	9.15	200	
P26-P27	C1A + C1B	2,271.3	1.00	169	0.107	350	7	9.4	9.1	9.35	9.05	140	
P27-P28	Minor local runoff	0.0	1.00	169	0.000	350	40	9.35	9.05	9.3	9.0	800	
P28-P29	C2C* 50%	150.1	1.00	169	0.007	350	15	9.3	9.0	9.25	8.95	300	
P29-P30	C2C	300.2	1.00	169	0.014	350	31	9.25	8.95	9.1	8.8	207	
P27-P30	C1A + C1B	2,271.3	1.00	169	0.107	350	19	9.35	9.05	9.1	8.8	76	
P30-P01	C1A + C1B + C2C	2,571.5	1.00	169	0.121	280	16	9.1	8.8	9	8.7	160	Outlet to Eastern Stream
Internal Pipeline													
Upstream	C1C + C2A	6,118.7	1.00	169	0.287	150	68	12		11.5		136	See separate pipeline calculations
Downstream	C1C + C2A + C2B	8,920.8	1.00	169	0.419	120	34	11.5		11.2		113	See separate pipeline calculations

[#] Note: Rainfall Intensity taken from overall runoff calculations for the Site

*Note: Minimum required gradient taken as 1:350, to provide full-flow velocity of 1m/s (Q = 0.108m³/s)

**C192 - Hong Kong & Kowloon Timber Merchants Association Yard at Lin Ma Hang Road
Proposed Drainage Capacity
Upstream End of Pipeline - Twin 400mm Pipelines**

Colebrook-white Equation in SI units, simplified for solution for D
(From "Tables for the Hydraulic Design of Pipes, Sewers & Channels" HR Wallingford)

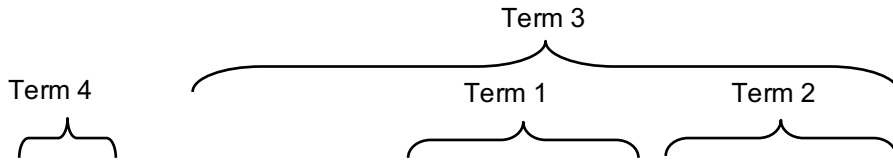

Assume uPVC pipes, normal condition

D	0.400 m	400 mm
S (1 in)	150	0.007 Assumed Gradient
Ks	0.06 mm	0.00006 m

Term 1	2.24987E-05
Term 2	1.65073E-05
Term 3	28.90013306

Term 4	28.89962337
--------	-------------

Diff 0 Should be zero for solution

Capacity, Q 0.239 m³/s

With 10% flow area allowance for sedimentation, assume 10% reduction in capacity:

Capacity, Q_{silt} = 0.215 m³/s/ pipe

A = 0.13 m²

v = Q/A = 1.90 m/s

Overall Capacity = 0.430 m³/s (twin pipes)

Appendix J

Figures

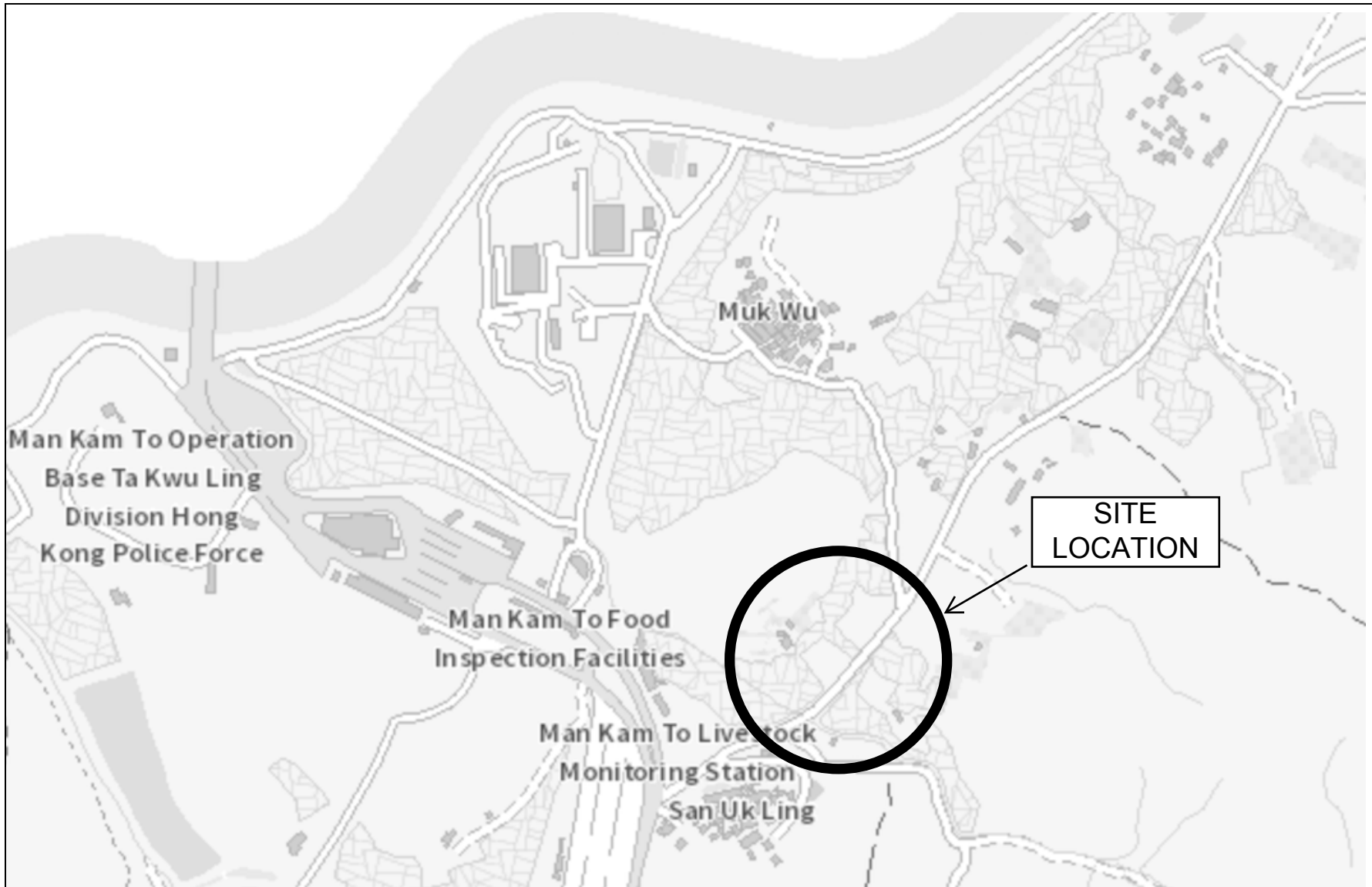

**Proposed Rural Workshop (Timber Yard and Sawmill) at Various Lots
in D.D.86, D.D. 90 and Adjoining Government Land, Lin Ma Hang
Road, San Uk Ling, Ma Kam To**

Site Location Plan

Figure 1

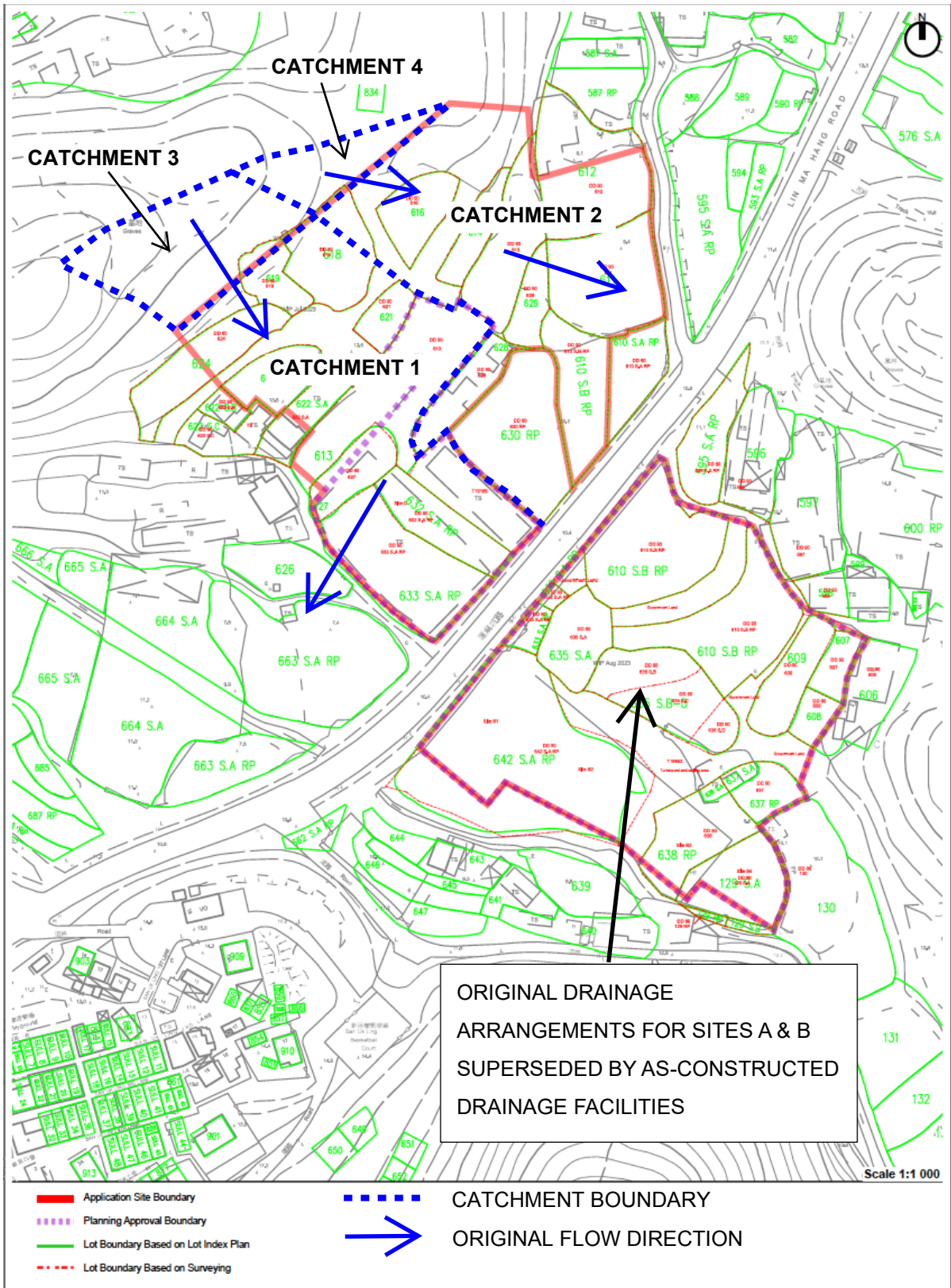

Proposed Rural Workshop (Timber Yard and Sawmill) at Various Lots in D.D.86, D.D. 90 and Adjoining Government Land, Lin Ma Hang Road, San Uk Ling, Ma Kam To

Existing/Original Local Drainage Arrangements

Figure 2

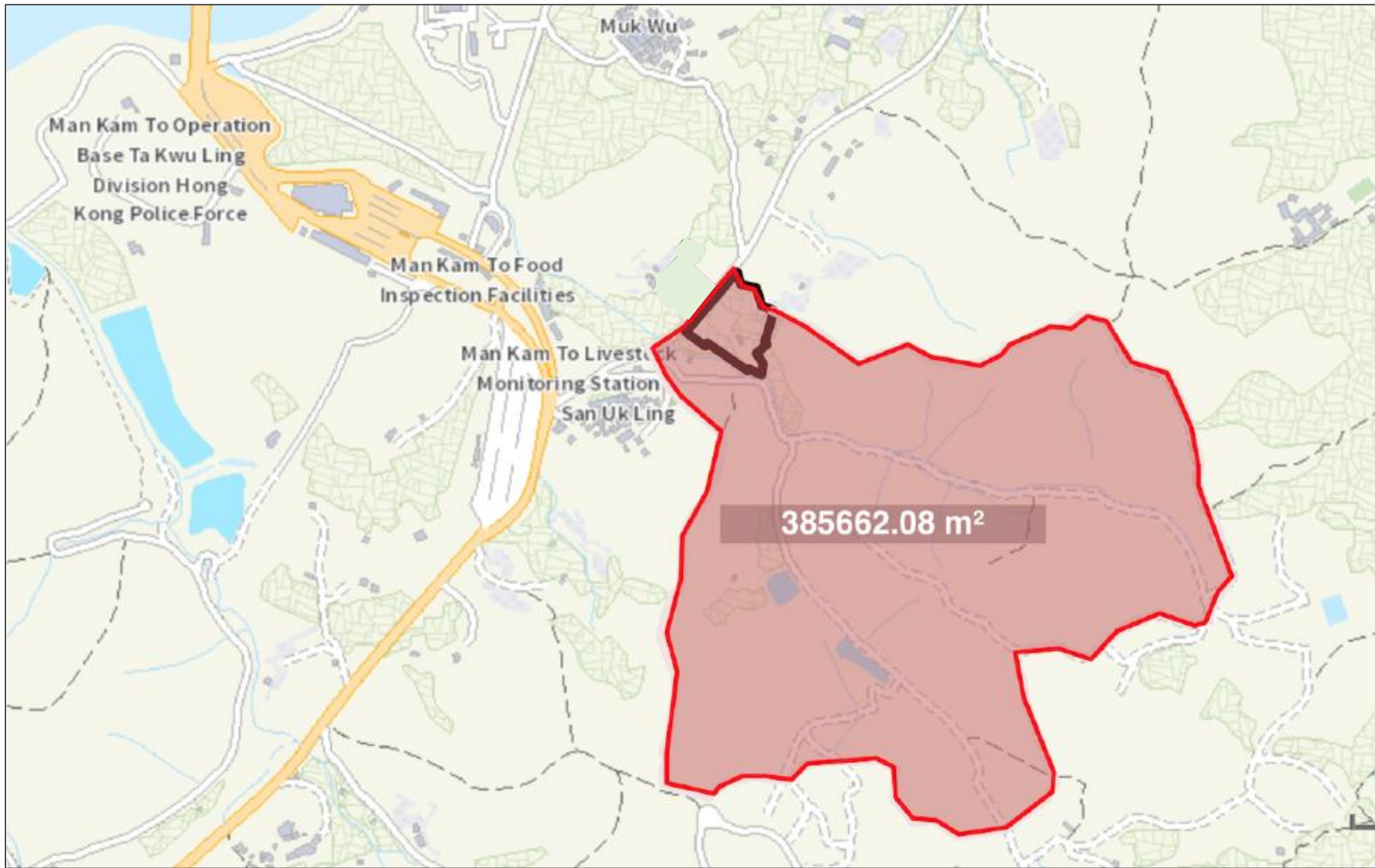

**Proposed Rural Workshop (Timber Yard and Sawmill) at Various Lots
in D.D.86, D.D. 90 and Adjoining Government Land,
Lin Ma Hang Road, San Uk Ling, Ma Kam To**

Overall Catchment Area (Eastern Site)

Figure 3

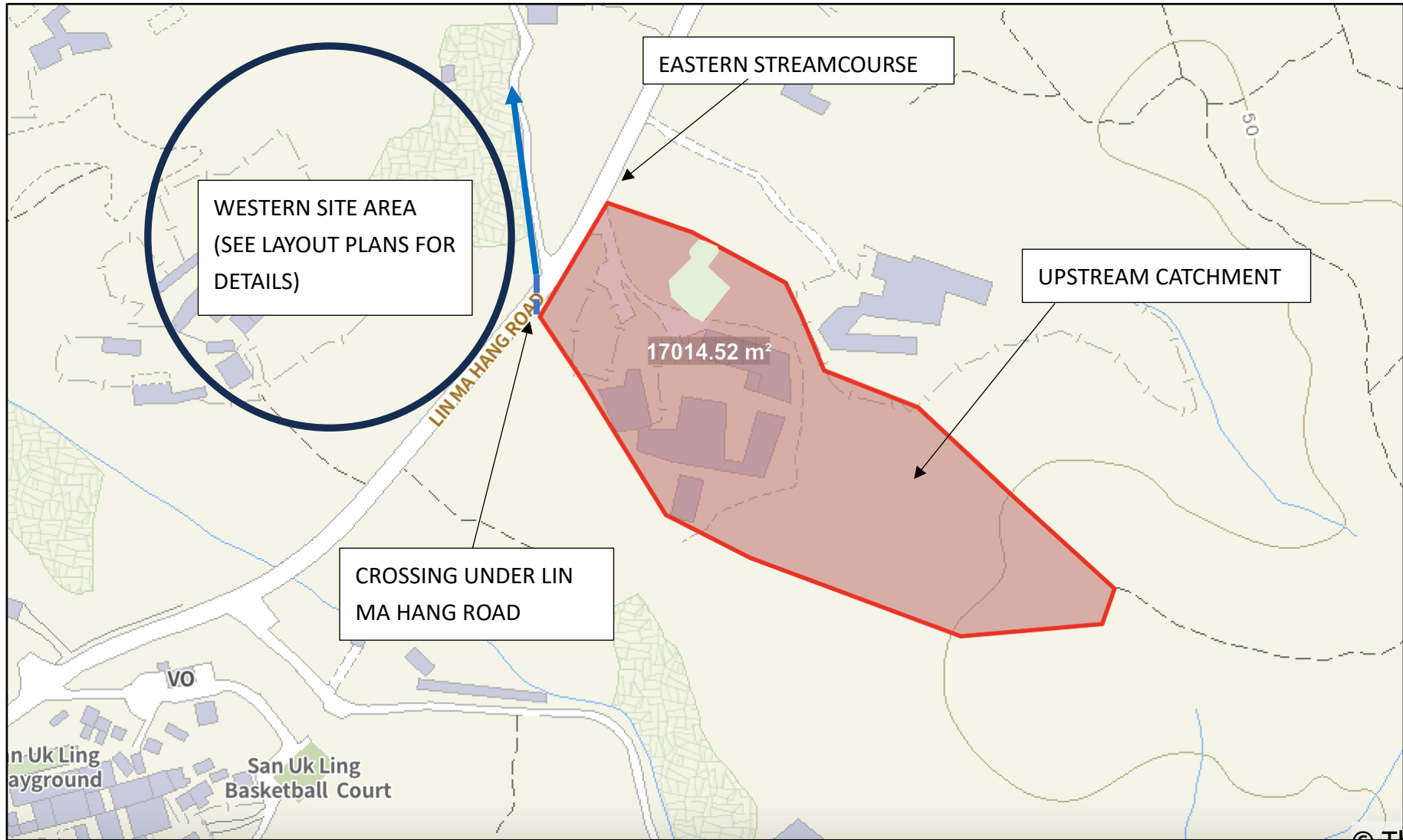

**Proposed Rural Workshop (Timber Yard and Sawmill) at Various Lots
in D.D.86, D.D. 90 and Adjoining Government Land,
Lin Ma Hang Road, San Uk Ling, Ma Kam To**

Upstream Catchment Area (Western Site)

Figure 4

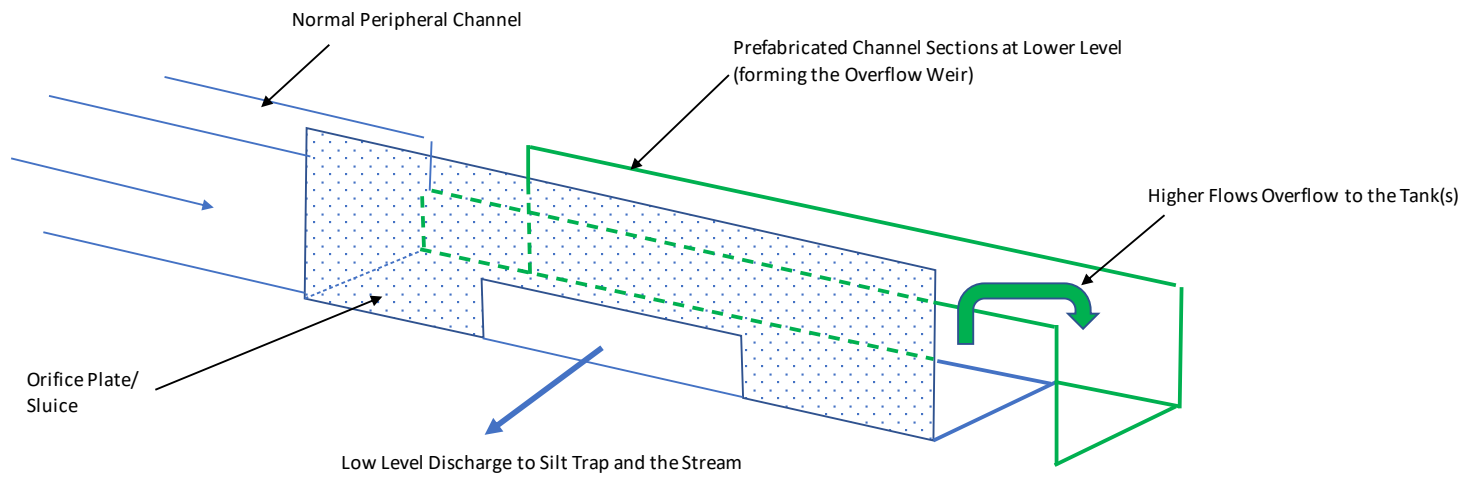

SCHEMATIC DIAGRAMME OF DISCHARGE/OVERFLOW ARRANGEMENT

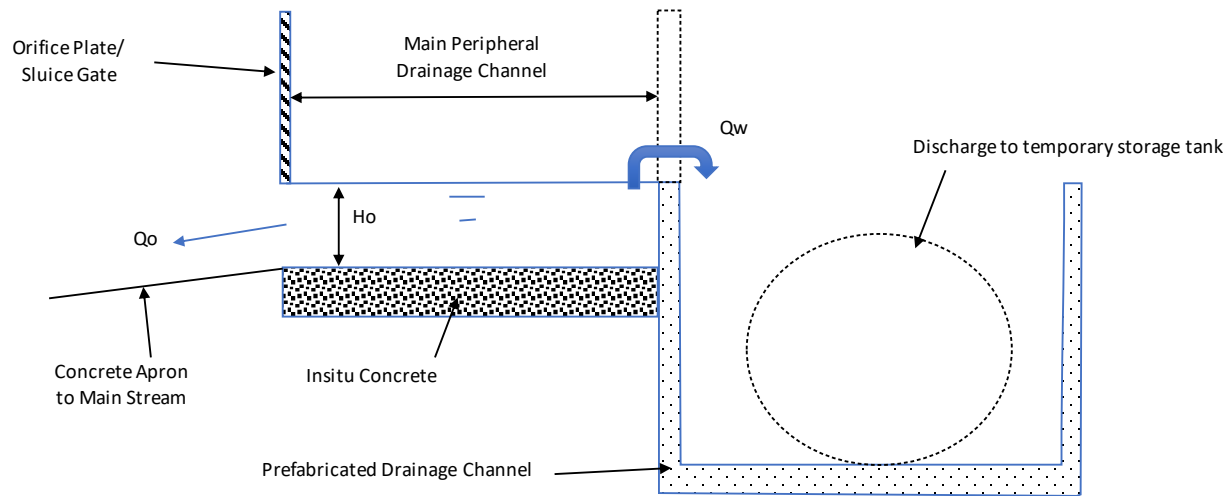

CROSS-SECTION THROUGH DISCHARGE/OVERFLOW CHAMBER

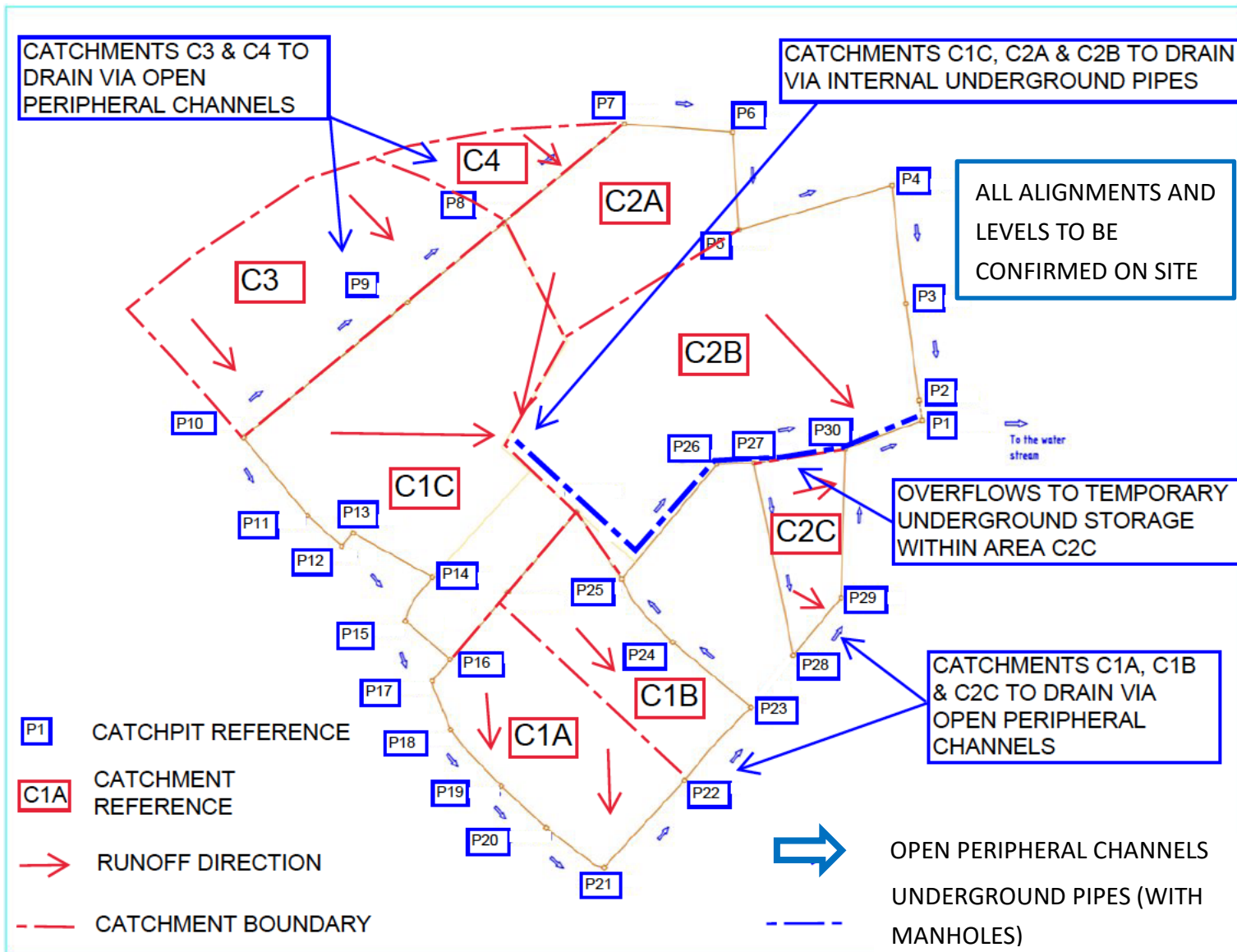

Proposed Rural Workshop (Timber Yard and Sawmill) at Various Lots in D.D.86, D.D. 90 and Adjoining Government Land, Lin Ma Hang Road, San Uk Ling, Ma Kam To	Site Catchments & Drainage Plan (Western Site)
	Figure 6