

LEGENDS

- VILLAGE
- G/IC GOVERNMENT, INSTITUTION OR COMMUNITY
- O OPEN SPACE
- R RESIDENTIAL
- REINSTATED SLOPE
- OXYGEN TANK (OUTDOOR AREA)
- CURRENT OZP BOUNDARY
- APPLICATION SITE BOUNDARY
- OVERALL DEVELOPMENT SITE BOUNDARY FOR REPROVISION OF TSUEN WAN WATER TREATMENT WORKS
- GLA BOUNDARY
- PAVED CONCRETE ROAD

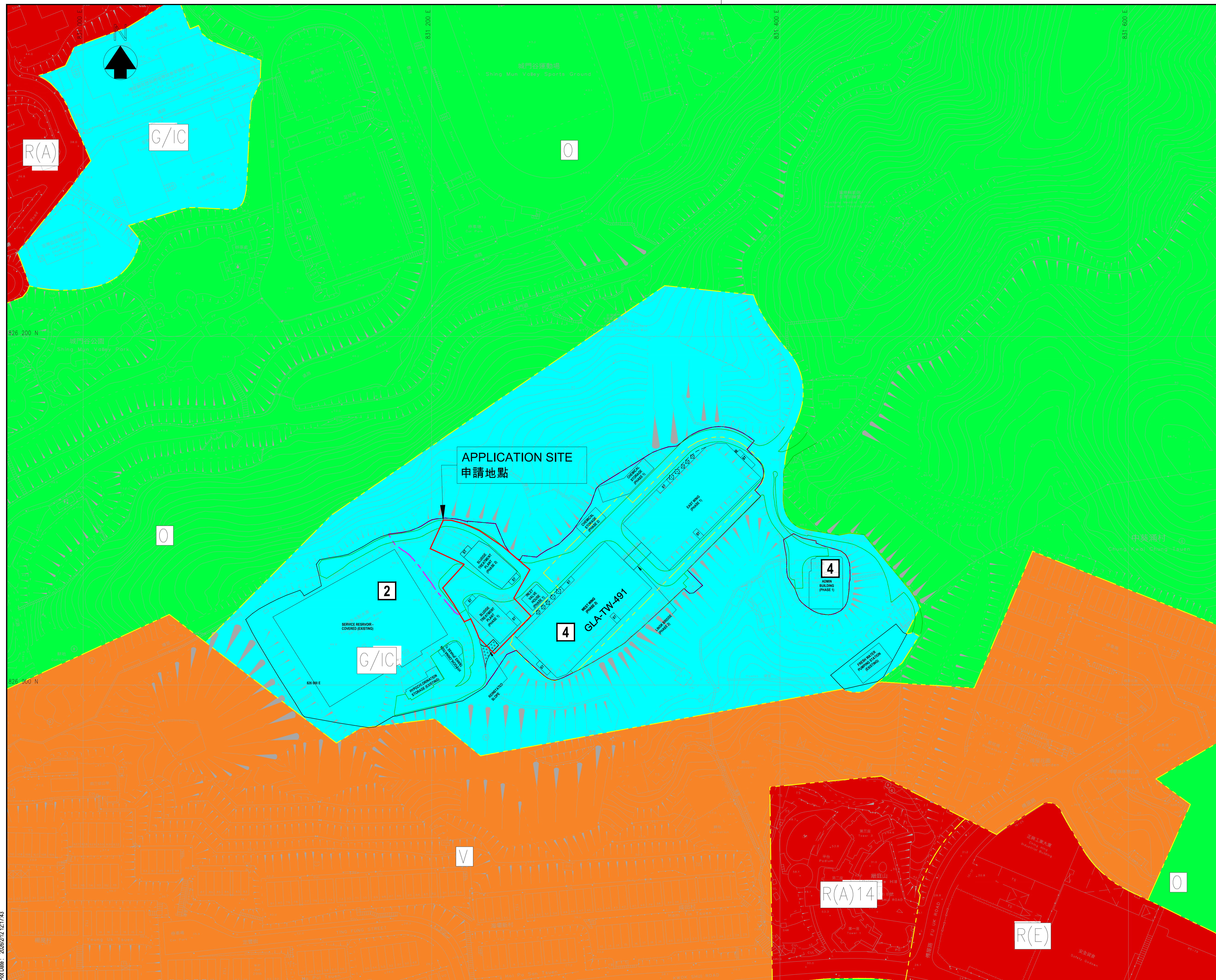

Revision	Date	Description			Initial
		Designed	Checked	Drawn	

Approved

Agreement No. CE 82/2022 (WS)

Contract Title
IN - SITU REPROVISIONING OF TSUEN WAN WATER TREATMENT WORKS - INVESTIGATION, DESIGN AND CONSTRUCTION

Drawing Title
MASTER LAYOUT PLAN WITH OUTLINE ZONING PLAN

Drawing No. **FIGURE 1** Revision -

Scale
A1 1 : 500
A3 1 : 1000



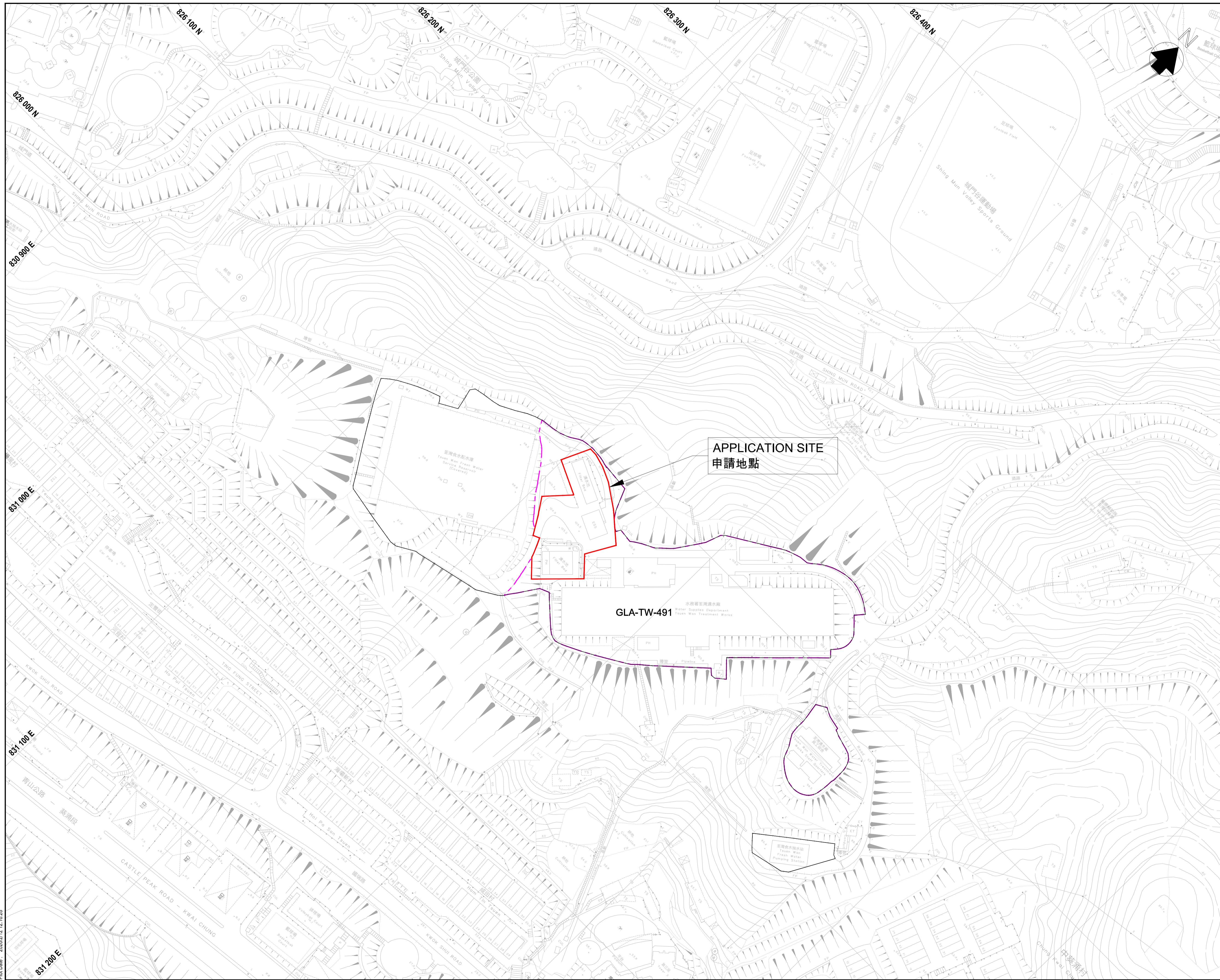

© Copyright by Binnies Hong Kong Limited

- LEGENDS:**
- APPLICATION SITE BOUNDARY
 - OVERALL DEVELOPMENT SITE BOUNDARY FOR REPROVISION OF TSUEN WAN WATER TREATMENT WORKS
 - GLA BOUNDARY

Revision	Date	Description			Initial
		Designed	Checked	Drawn	
Initial					
Date					

Approved

Agreement No. CE 82/2022 (WS)

Contract Title
IN - SITU REPROVISIONING OF TSUEN WAN WATER TREATMENT WORKS - INVESTIGATION, DESIGN AND CONSTRUCTION

Drawing Title
LOCATION PLAN

Drawing No. **FIGURE 2** Revision -

Scale
A1 1 : 1000
A3 1 : 2000



Plot Date : 2026/01/12 16:28

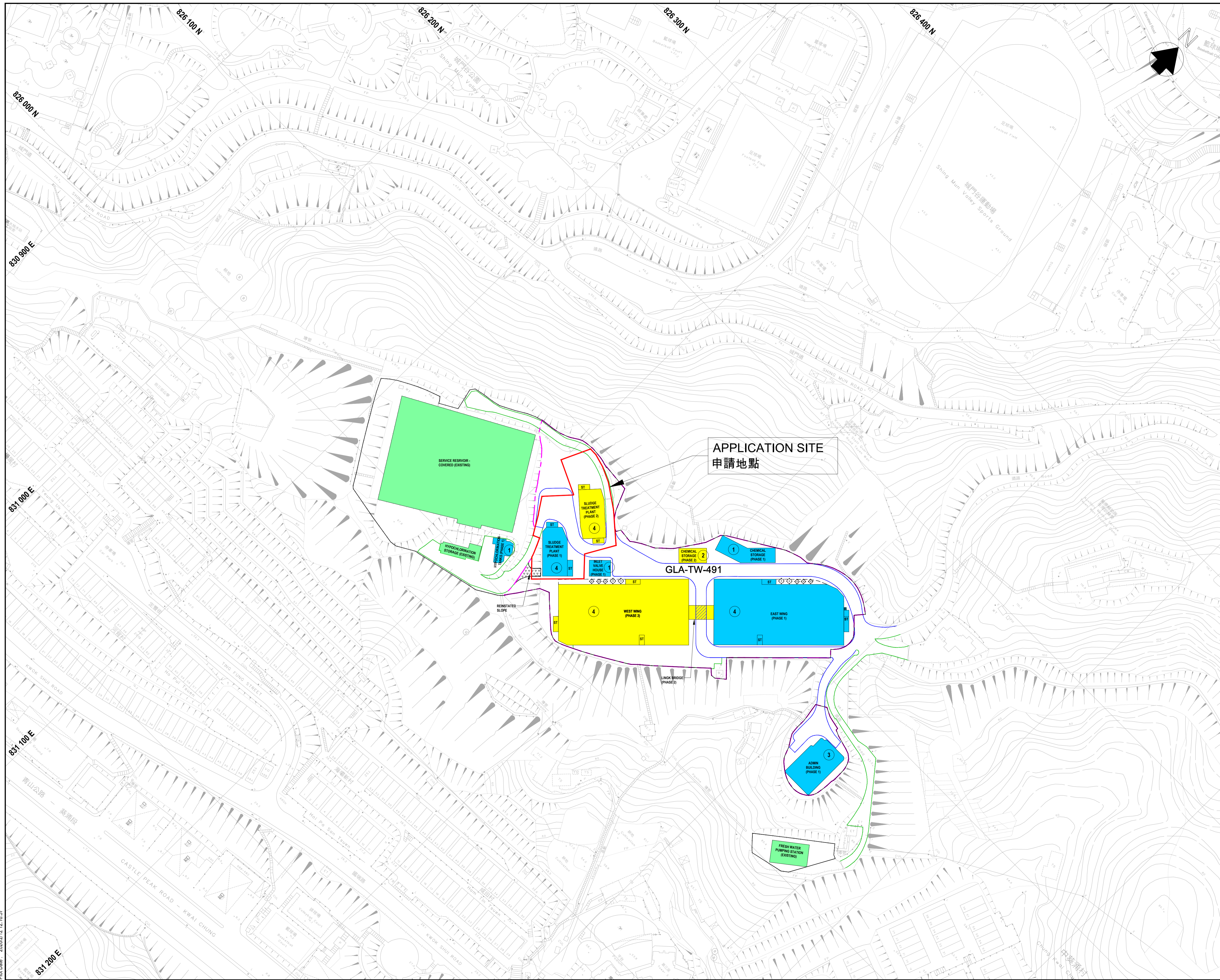

© Copyright by Binnies Hong Kong Limited

- LEGENDS**
- EXISTING FACILITIES
 - NEW FACILITIES (PHASE 1)
 - NEW FACILITIES (PHASE 2)
 - REINSTATED SLOPE
 - DRIVEWAY UNDER BUILDING
 - PAVED CONCRETE BOUNDARY
 - PERMANENT DRIVEWAY
 - OXYGEN TANK (OUTDOOR AREA)
 - APPLICATION SITE BOUNDARY
 - OVERALL DEVELOPMENT SITE BOUNDARY FOR REPROVISION OF TSUEN WAN WATER TREATMENT WORKS
 - GLA BOUNDARY
 - BUILDING HEIGHT (NO. OF STORES)

Revision	Date	Description			Initial
		Designed	Checked	Drawn	
Initial					
Date					

Approved

Agreement No. CE 82/2022 (WS)

Contract Title
IN - SITU REPROVISIONING OF TSUEN WAN WATER TREATMENT WORKS - INVESTIGATION, DESIGN AND CONSTRUCTION

Drawing Title
MASTER LAYOUT PLAN

Drawing No. **FIGURE 3** Revision -

Scale
A1 1 : 1000
A3 1 : 2000



Plot Date : 2026/01/12 16:57



- LEGEND:**
- APPLICATION SITE BOUNDARY
 - - - OVERALL DEVELOPMENT SITE BOUNDARY FOR REPROVISION OF TSUEN WAN WATER TREATMENT WORKS
 - GLA BOUNDARY
 - ACCESS FROM MAIN ROAD TO THE APPLICATION SITE
 - ACCESS FROM THE APPLICATION SITE TO MAIN ROAD

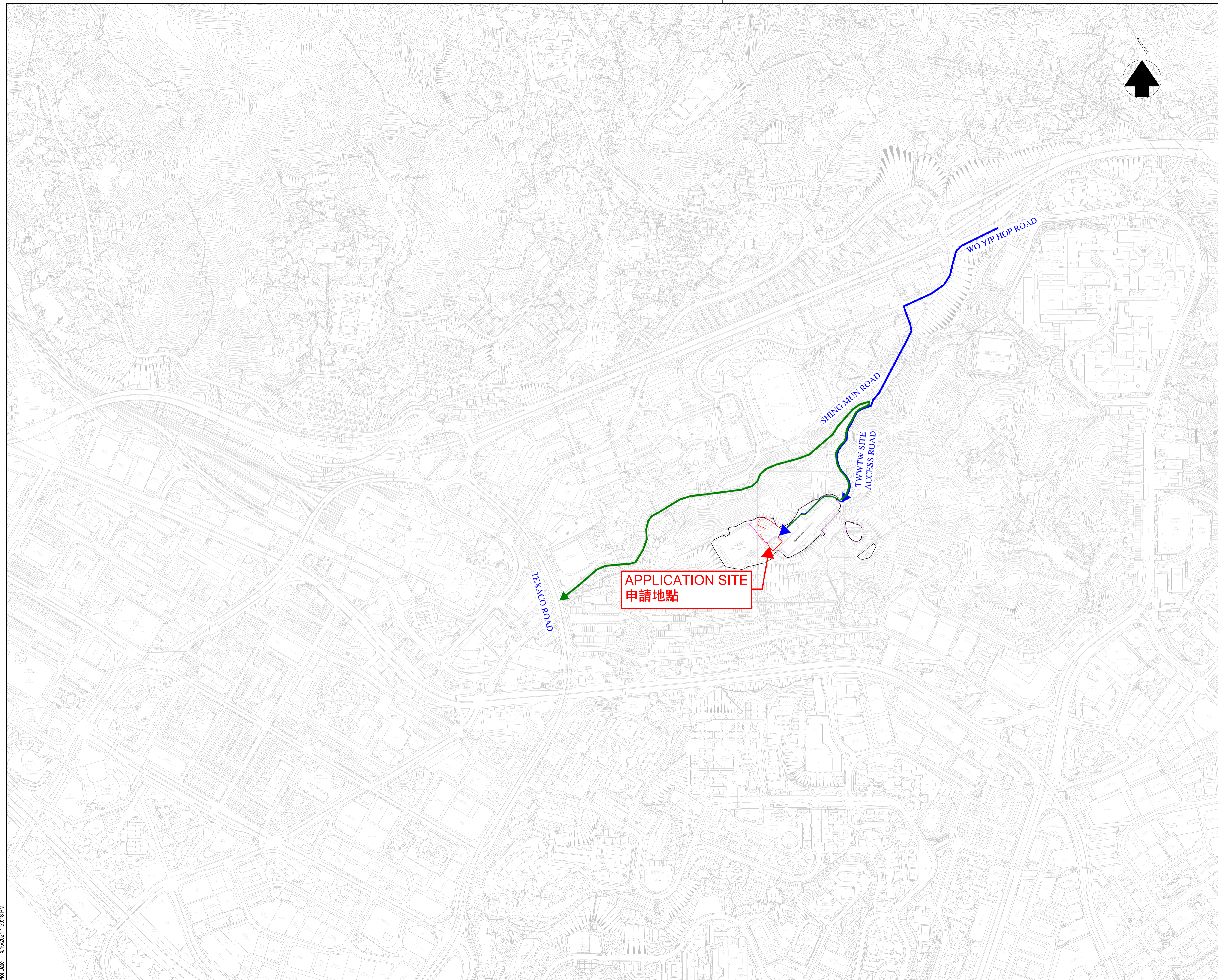

Revision	Date	Description			Initial
		Designed	Checked	Drawn	
Initial	LYS	SFL	SZ	SFL	SFL
Date	02/24	02/24	02/24	02/24	02/24

Approved

Contract No. CE 82/2022 (WS)

Contract Title
IN - SITU REPROVISIONING OF TSUEN WAN WATER TREATMENT WORKS - INVESTIGATION, DESIGN AND CONSTRUCTION

Drawing Title

SITE ACCESS PLAN

Drawing No. **FIGURE 4** Revision -

Scale A1 1:4000 A3 1:8000



LEGEND:

- APPLICATION SITE BOUNDARY
- DEVELOPMENT SITE AREA BOUNDARY
- GLA BOUNDARY
- ① → FIGURE NUMBER AND VIEW DIRECTION



Revision	Date	Description			Initial
		Designed	Checked	Drawn	
Initial	—	—	—	SZ	LB
Date	08/25	08/25	08/25	08/25	08/25

Approved

Agreement No. CE 82/2022 (WS)

Contract Title
IN - SITU REPROVISIONING OF TSUEN WAN WATER TREATMENT WORKS - INVESTIGATION, DESIGN AND CONSTRUCTION

Drawing Title
EXISTING SITE PHOTO RECORD PLAN

Drawing No. **FIGURE 5** Revision —

Scale A1 1 : 1000 A3 1 : 2000



FIGURE 6

Site Photo 1 - Existing Main Gate to TWWTW



FIGURE 7
Site Photo 2 - Existing Pumping House



FIGURE 8

Site Photo 3 - Existing Dangerous Good Containers and Pumping House



FIGURE 9

Site Photo 4 - Existing Access Road



FIGURE 10
Site Photo 5 - Existing On-site Chlorine Generation



FIGURE 11

Site Photo 6 - Existing On-site Chlorine Generation



FIGURE 12

Site Photo 7 - Existing Chlorination House (Not in Used)



FIGURE 13

Site Photo 8 - Existing Chlorination House (Not in Used)



FIGURE 14

Site Photo 9 - Existing Inlet Valve House and E&M Workshop



FIGURE 15

Site Photo 10 - Existing Sludge Holding Tanks



FIGURE 16

Site Photo 11 - Existing West Wing and Sludge Holding Tanks



FIGURE 17

Site Photo 12 - Existing Access Road and Washwater Recovery Tanks



FIGURE 18

Site Photo 13 - Existing East Wing



FIGURE 19
Site Photo 14 - Existing West Wing



FIGURE 20

Site Photo 15 - Junction of Shing Mun Road to TWWTW



FIGURE 21

Site Photo 16 - Access Road to TWWTW





Revision	Date	Description			Initial
		Designed	Checked	Drawn	

Approved

Agreement No.
CE 82/2022 (WS)

Contract Title
IN - SITU REPROVISIONING OF TSUEN WAN WATER TREATMENT WORKS - INVESTIGATION, DESIGN AND CONSTRUCTION

Drawing Title
RENDERING

Drawing No. FIGURE 22	Revision -
---------------------------------	---------------

Scale N.T.S.



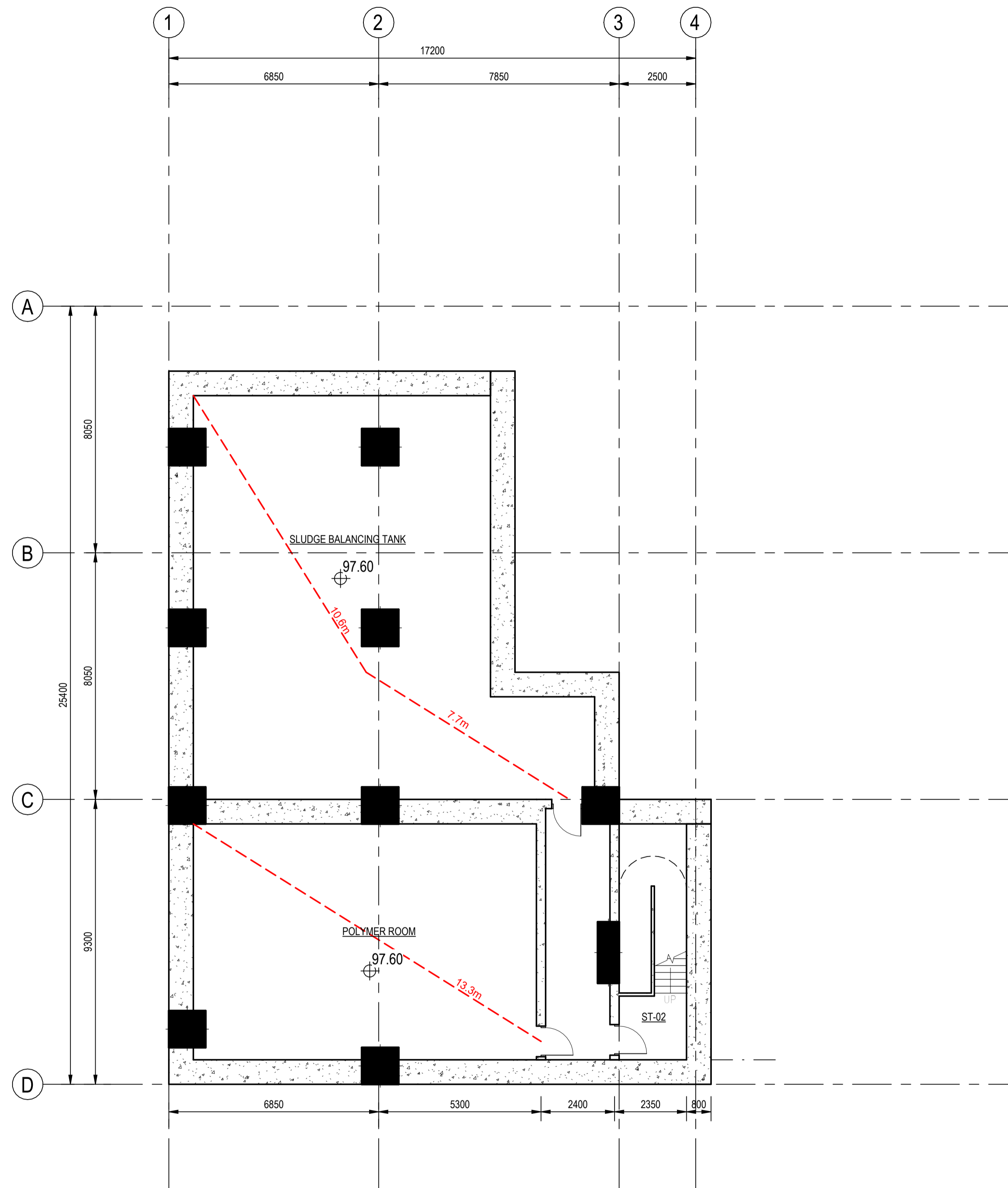

BASEMENT FLOOR
SCALE 1 : 100

Revision	Date	Description			Initial
		Designed	Checked	Drawn	Checked
		Designer	Checker	Author	
		Approved			

Agreement No. CE 82 / 2022 (WS)

Contract Title
IN - SITU REPROVISIONING OF TSUEN WAN WATER TREATMENT WORKS - INVESTIGATION, DESIGN AND CONSTRUCTION -

Drawing Title
GENERAL ARRANGEMENT - SLUDGE TREATMENT PLANT (PHASE 1) - BASEMENT FLOOR

Drawing No. **FIGURE 23** Revision

Scale A1 1 : 100

Client
 水務署
Water Supplies Department

Consultant
 **binnies**
BINNIES HONG KONG LIMITED
賓尼斯工程顧問有限公司

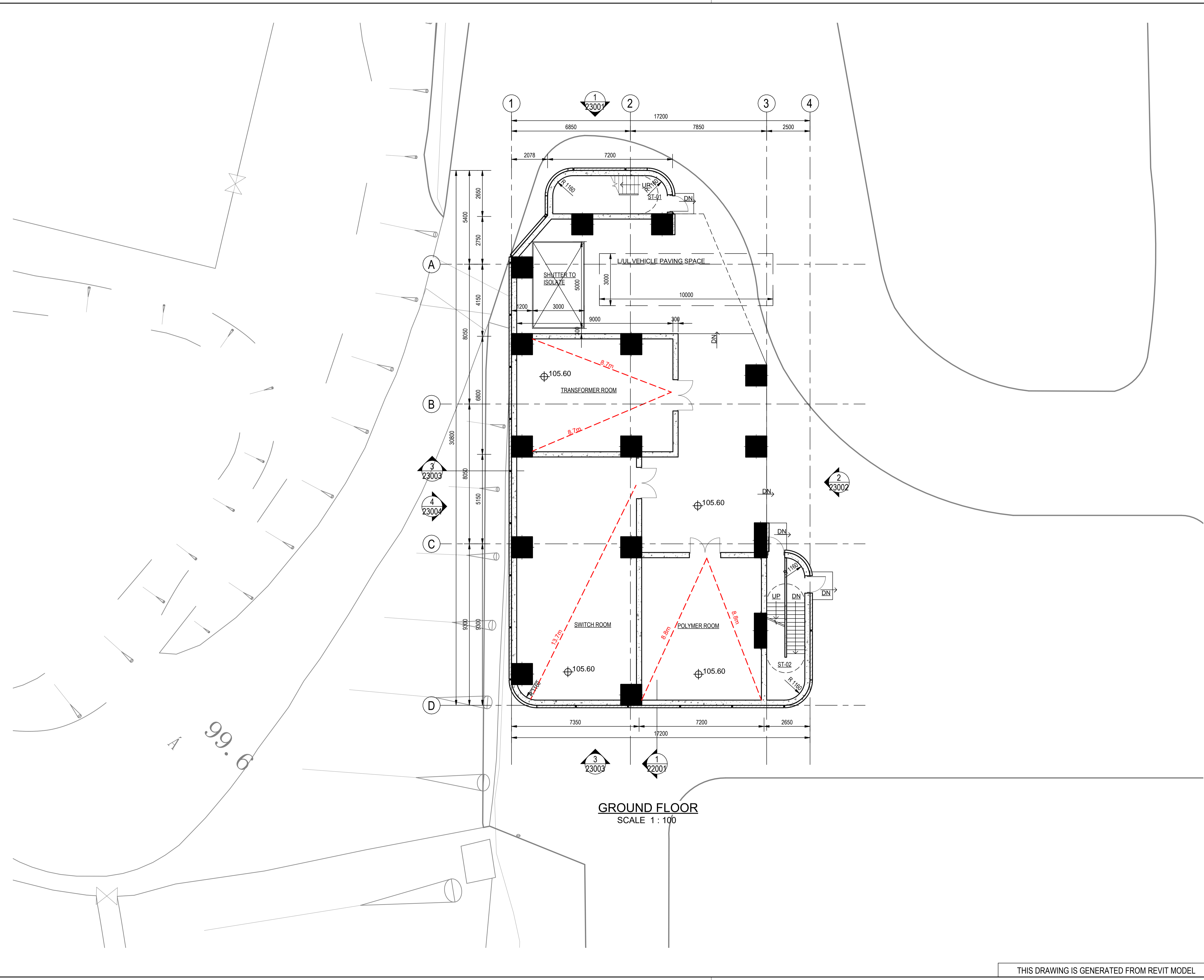

Revision	Date	Description			Initial
		Designed	Checked	Drawn	Checked
		Designer	Checker	Author	

Approved

Agreement No. CE 82 / 2022 (WS)

Contract Title
IN - SITU REPROVISIONING OF TSUEN WAN WATER TREATMENT WORKS - INVESTIGATION, DESIGN AND CONSTRUCTION -

Drawing Title
GENERAL ARRANGEMENT - SLUDGE TREATMENT PLANT (PHASE 1) - GROUND FLOOR

Drawing No. FIGURE 24

Scale A1 1:100

Client
水務署
Water Supplies Department

Consultant
binnies
BINNIES HONG KONG LIMITED
賓尼斯工程顧問有限公司

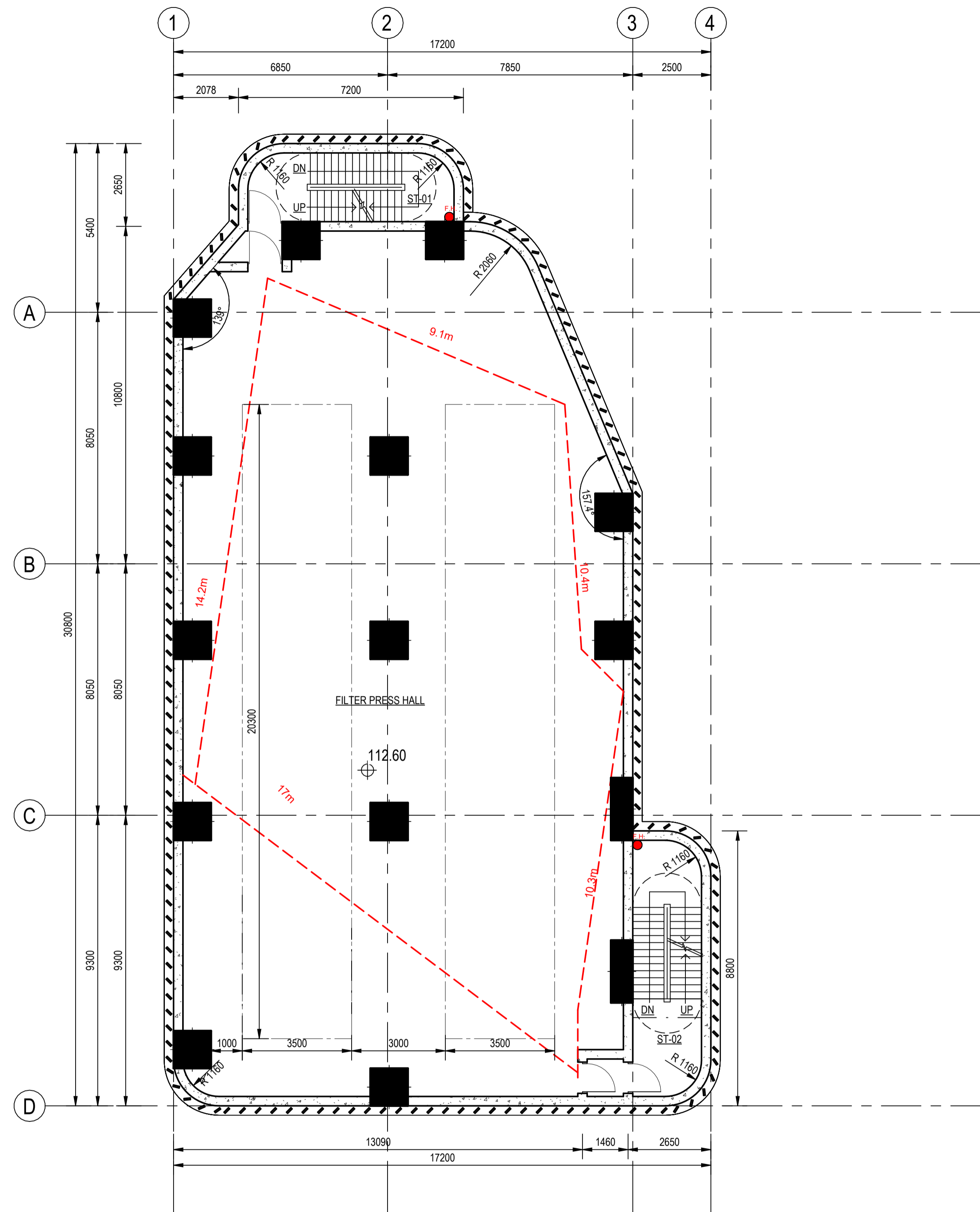

FIRST FLOOR
SCALE 1 : 100

Revision	Date	Description			Initial
		Designed	Checked	Drawn	
Initial	Designer	Checker	Author		
Date					
Approved					

Agreement No. CE 82 / 2022 (WS)

Contract Title
IN - SITU REPROVISIONING OF TSUEN WAN WATER TREATMENT WORKS - INVESTIGATION, DESIGN AND CONSTRUCTION -

Drawing Title
GENERAL ARRANGEMENT - SLUDGE TREATMENT PLANT (PHASE 1) - FIRST FLOOR

Drawing No. FIGURE 25

Scale A1 1 : 100

Client
 水務署
Water Supplies Department

Consultant
 BINNIES HONG KONG LIMITED
賓尼斯工程顧問有限公司

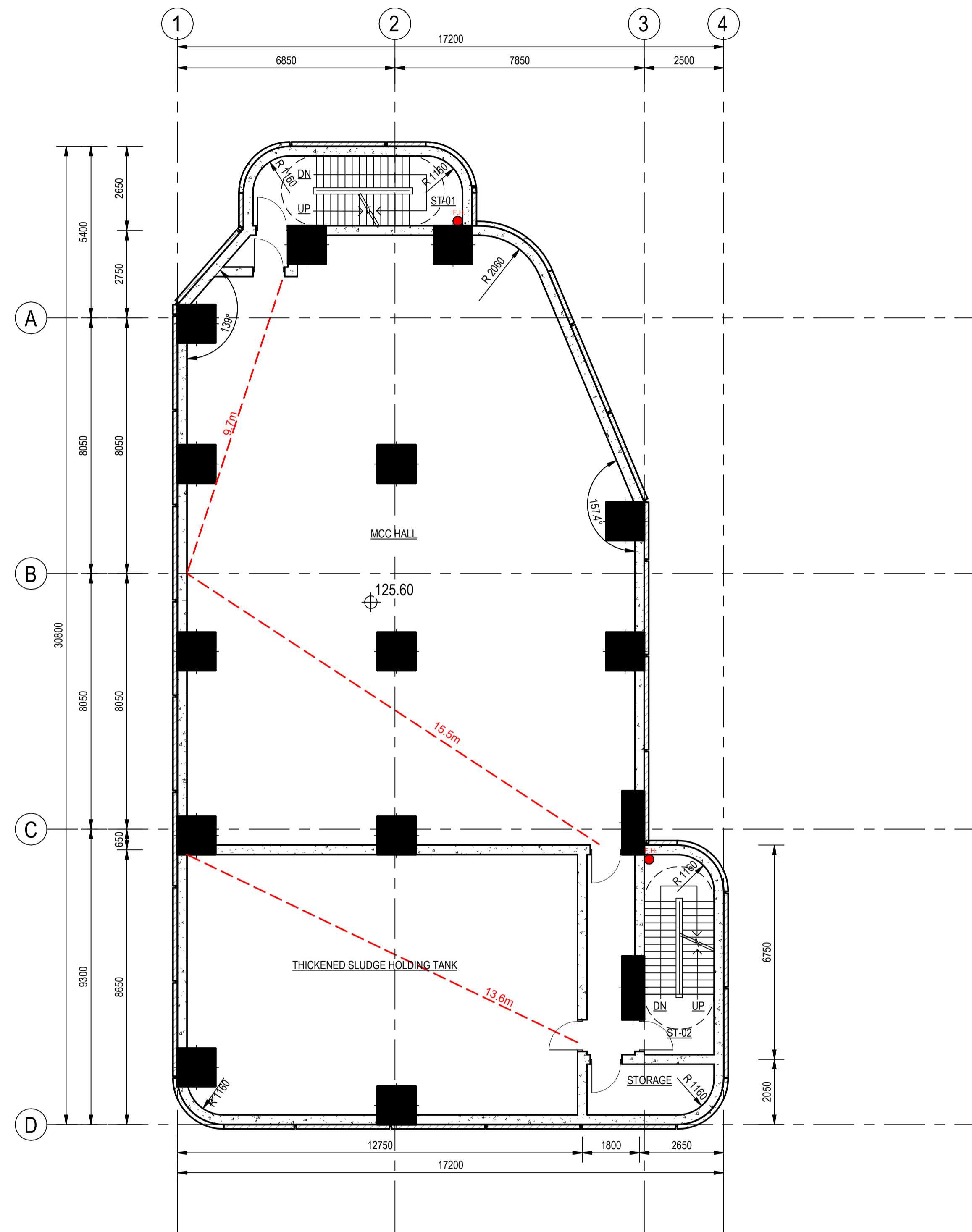

SECOND FLOOR
SCALE 1 : 100

Revision	Date	Description			Initial
		Designed	Checked	Drawn	Checked
		Designer	Checker	Author	

Approved

Agreement No.
CE 82 / 2022 (WS)

Contract Title
IN - SITU REPROVISIONING OF TSUEN WAN WATER TREATMENT WORKS - INVESTIGATION, DESIGN AND CONSTRUCTION -

Drawing Title
GENERAL ARRANGEMENT - SLUDGE TREATMENT PLANT (PHASE 1) - SECOND FLOOR

Drawing No. **FIGURE 26** Revision

Scale
A1 1 : 100

Client
 水務署
Water Supplies Department

Consultant
 BINNIES HONG KONG LIMITED
賓尼斯工程顧問有限公司

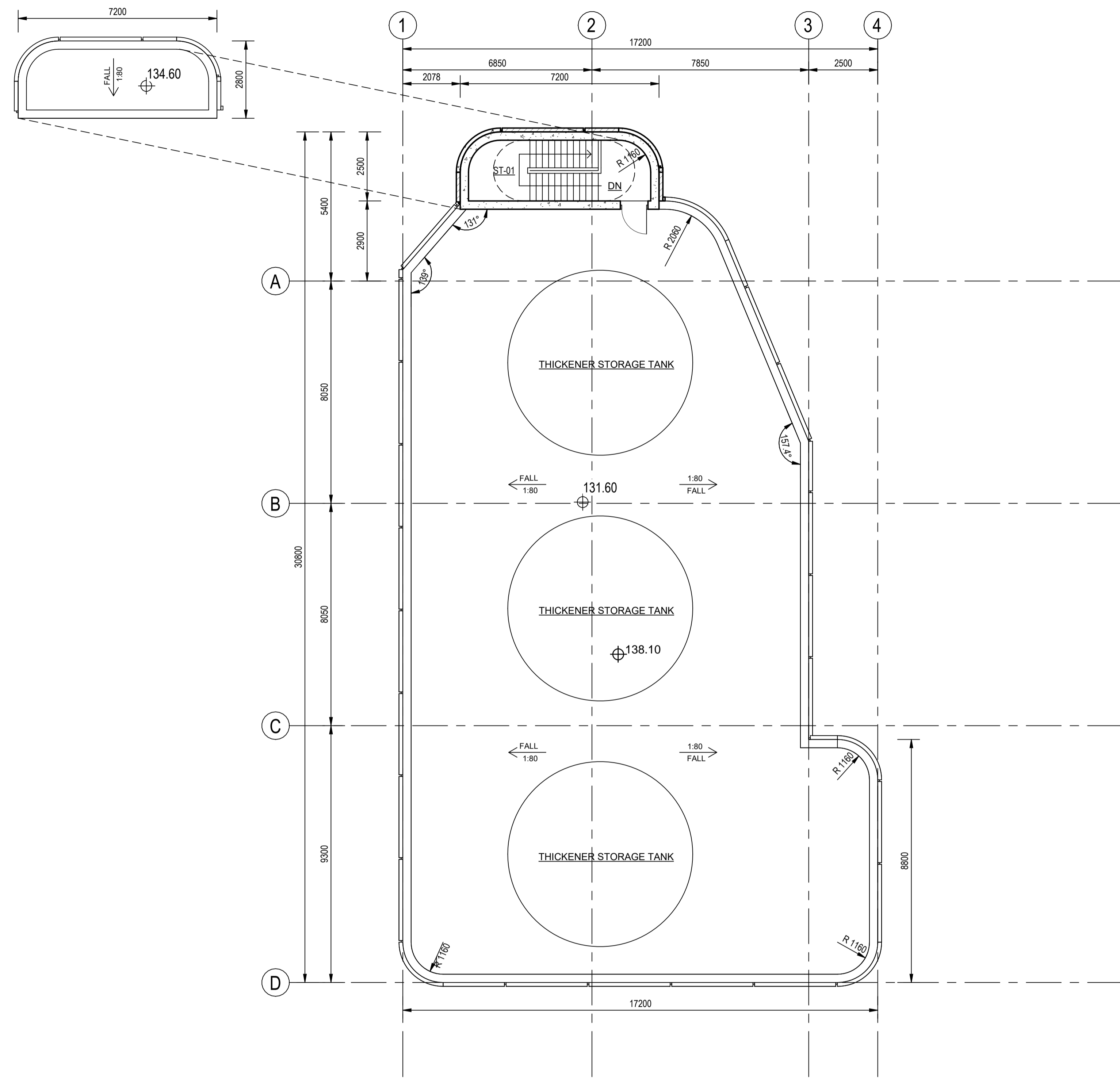

ROOF FLOOR
SCALE 1 : 100

Revision	Date	Description			Initial
		Designed	Checked	Drawn	Checked
		Designer	Checker	Author	
Approved					

Agreement No. CE 82 / 2022 (WS)

Contract Title
IN - SITU REPROVISIONING OF TSUEN WAN WATER TREATMENT WORKS - INVESTIGATION, DESIGN AND CONSTRUCTION -

Drawing Title
GENERAL ARRANGEMENT - SLUDGE TREATMENT PLANT (PHASE 1) - ROOF FLOOR

Drawing No. **FIGURE 27** Revision

Scale A1 1 : 100

Client
 水務署
Water Supplies Department

Consultant
 **binnies**
BINNIES HONG KONG LIMITED
賓尼斯工程顧問有限公司

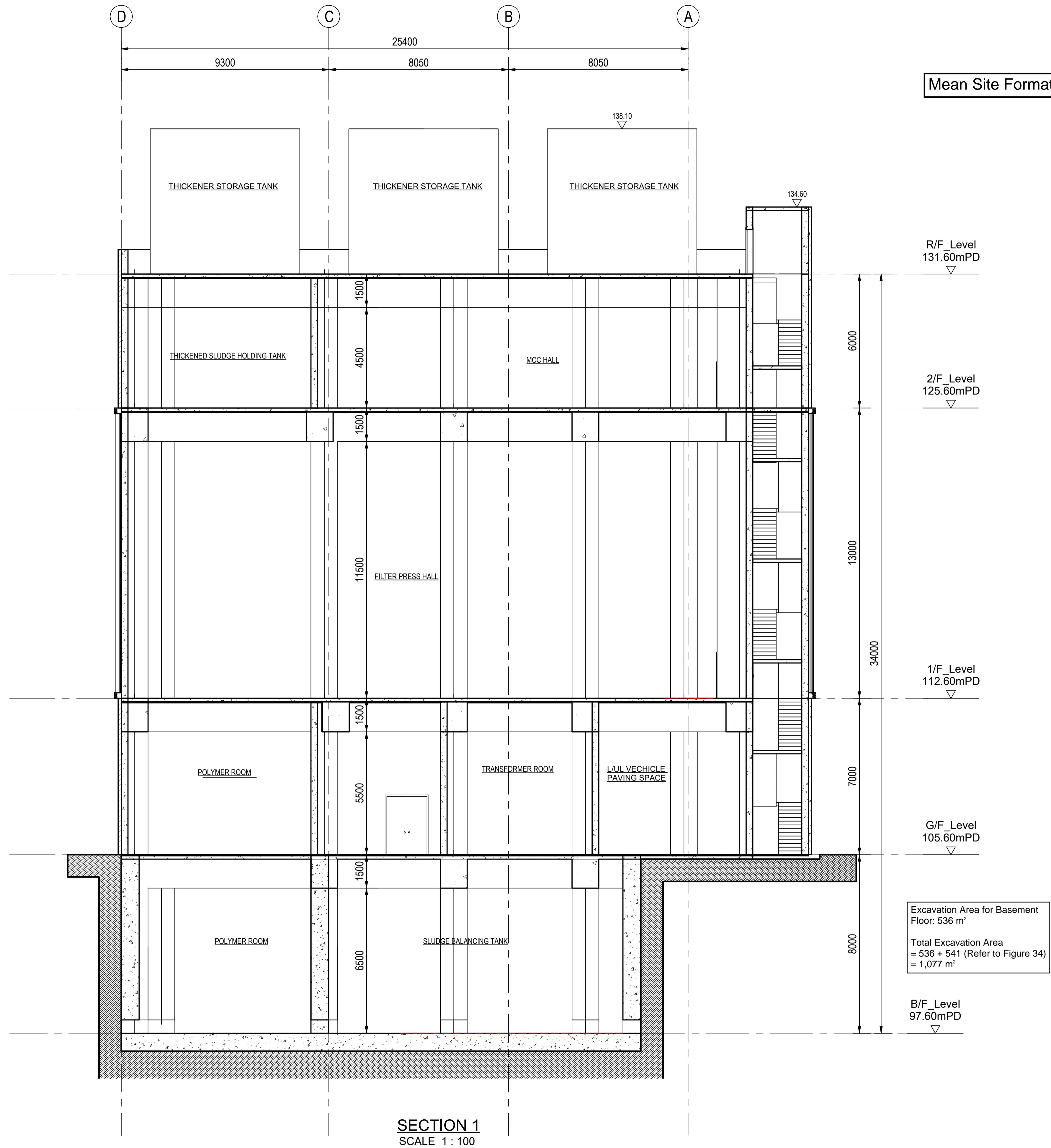

Mean Site Formation Level: 96.10 mPD

SECTION 1
SCALE 1 : 100

Revision	Date	Description			Initial
		Designed	Checked	Drawn	
Initial		Designer	Checker	Author	
Date					
Approved					

Agreement No. CE 82 / 2022 (WS)

Contract Title
IN - SITU REPROVISIONING OF TSUEN WAN WATER TREATMENT WORKS - INVESTIGATION, DESIGN AND CONSTRUCTION -

Drawing Title
GENERAL ARRANGEMENT - SLUDGE TREATMENT PLANT (PHASE 1) - SECTION 1

Drawing No. FIGURE 28

Scale A1 1 : 100



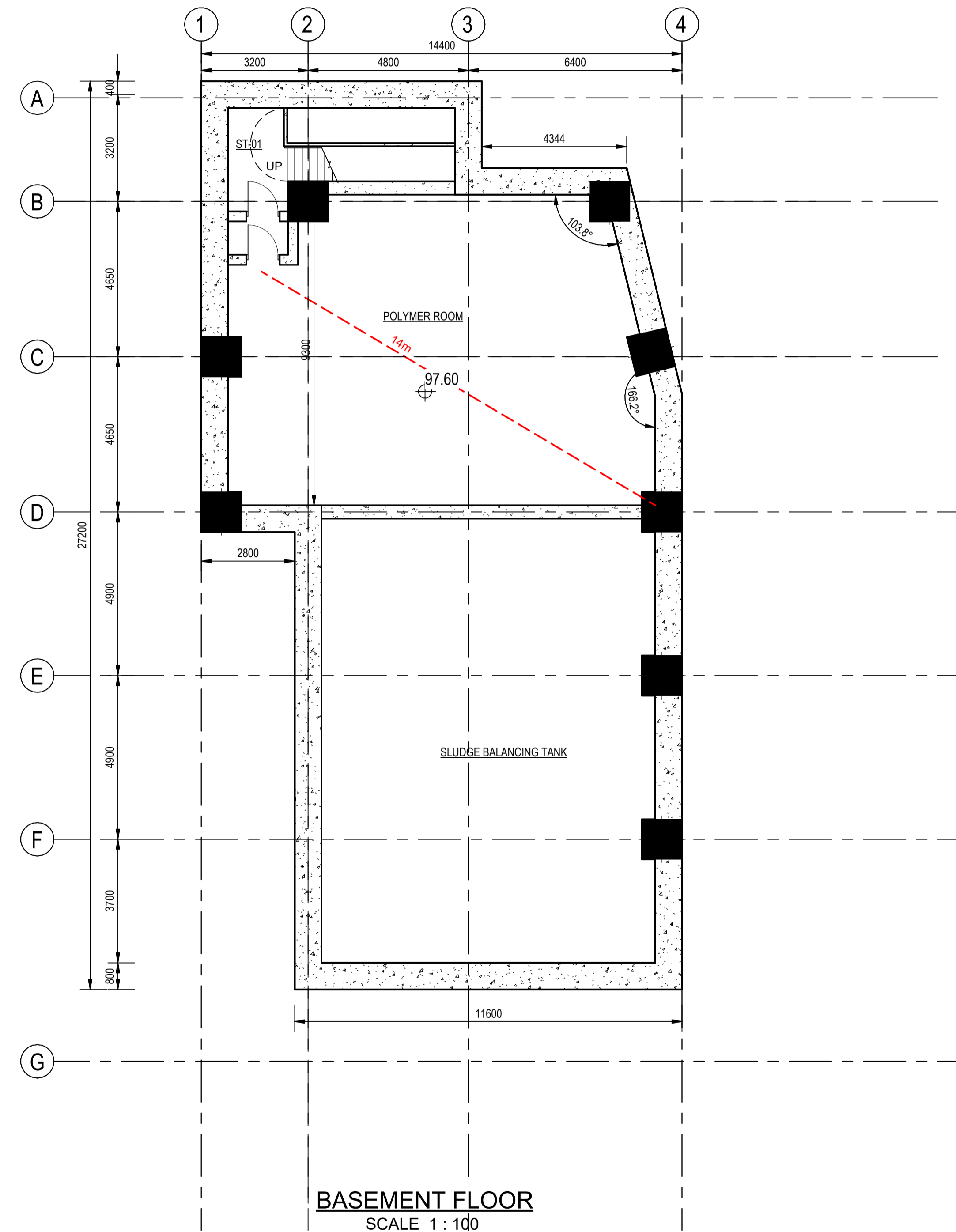

Revision	Date	Description			Initial
		Designed	Checked	Drawn	
Initial	Designer	Checker	Author		
Date					

Approved

Agreement No. CE 82 / 2022 (WS)

Contract Title
IN - SITU REPROVISIONING OF TSUEN WAN WATER TREATMENT WORKS - INVESTIGATION, DESIGN AND CONSTRUCTION -

Drawing Title
GENERAL ARRANGEMENT - SLUDGE TREATMENT PLANT (PHASE 2) - BASEMENT FLOOR

Drawing No. FIGURE 29

Scale A1 1 : 100

Client
 水務署
Water Supplies Department

Consultant
 BINNIES HONG KONG LIMITED
賓尼斯工程顧問有限公司

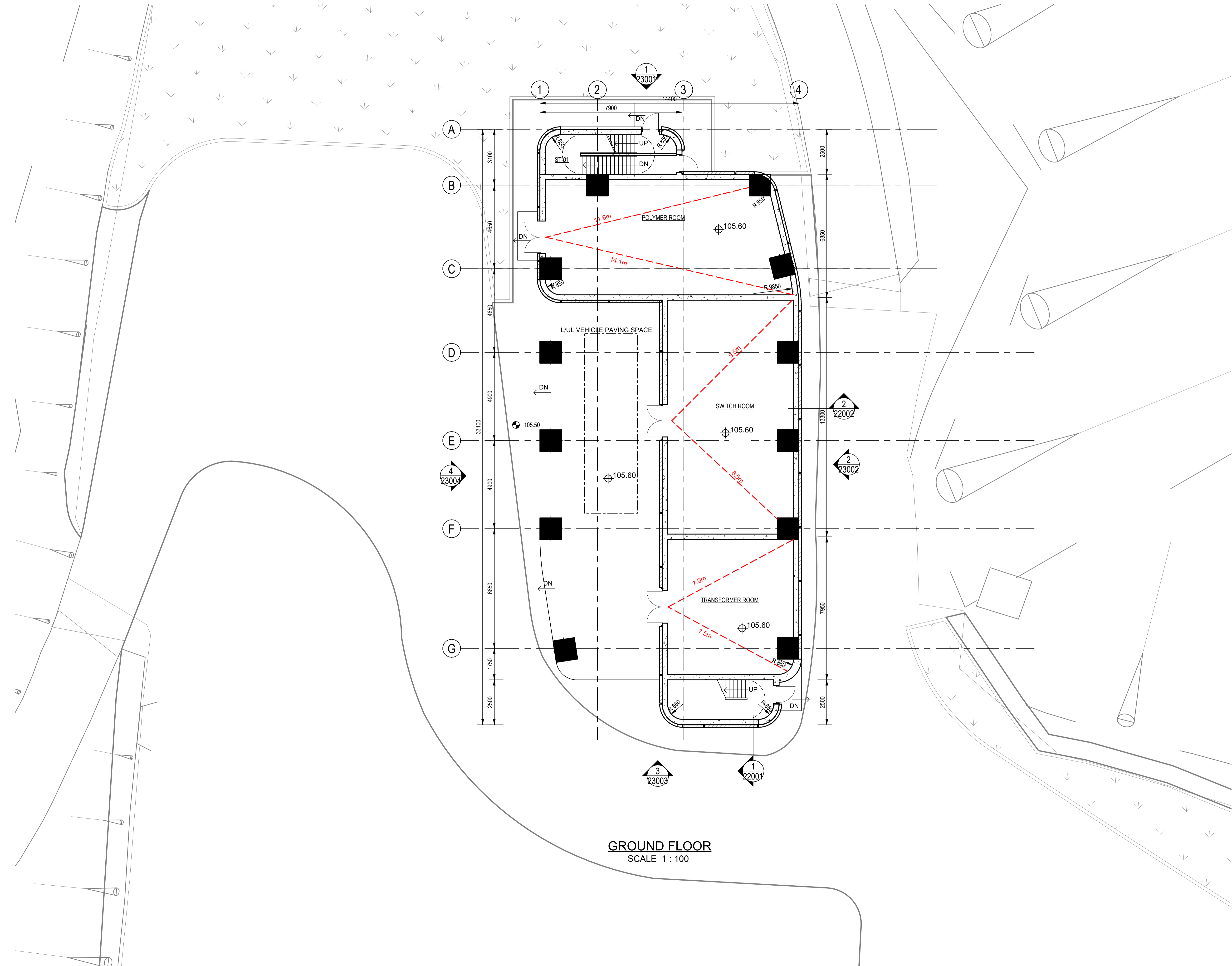

Revision	Date	Description			Initial
		Designed	Checked	Drawn	
Initial	Designer	Checker	Author		
Date					

Approved

Agreement No. CE 82 / 2022 (WS)

Contract Title
 IN - SITU REPROVISIONING OF TSUEN WAN WATER TREATMENT WORKS - INVESTIGATION, DESIGN AND CONSTRUCTION -

Drawing Title
 GENERAL ARRANGEMENT - SLUDGE TREATMENT PLANT (PHASE 2) - GROUND FLOOR

Drawing No. FIGURE 30

Scale A1 1: 100

Client
 水務署
 Water Supplies Department

Consultant

 BINNIES HONG KONG LIMITED
 賓尼斯工程顧問有限公司

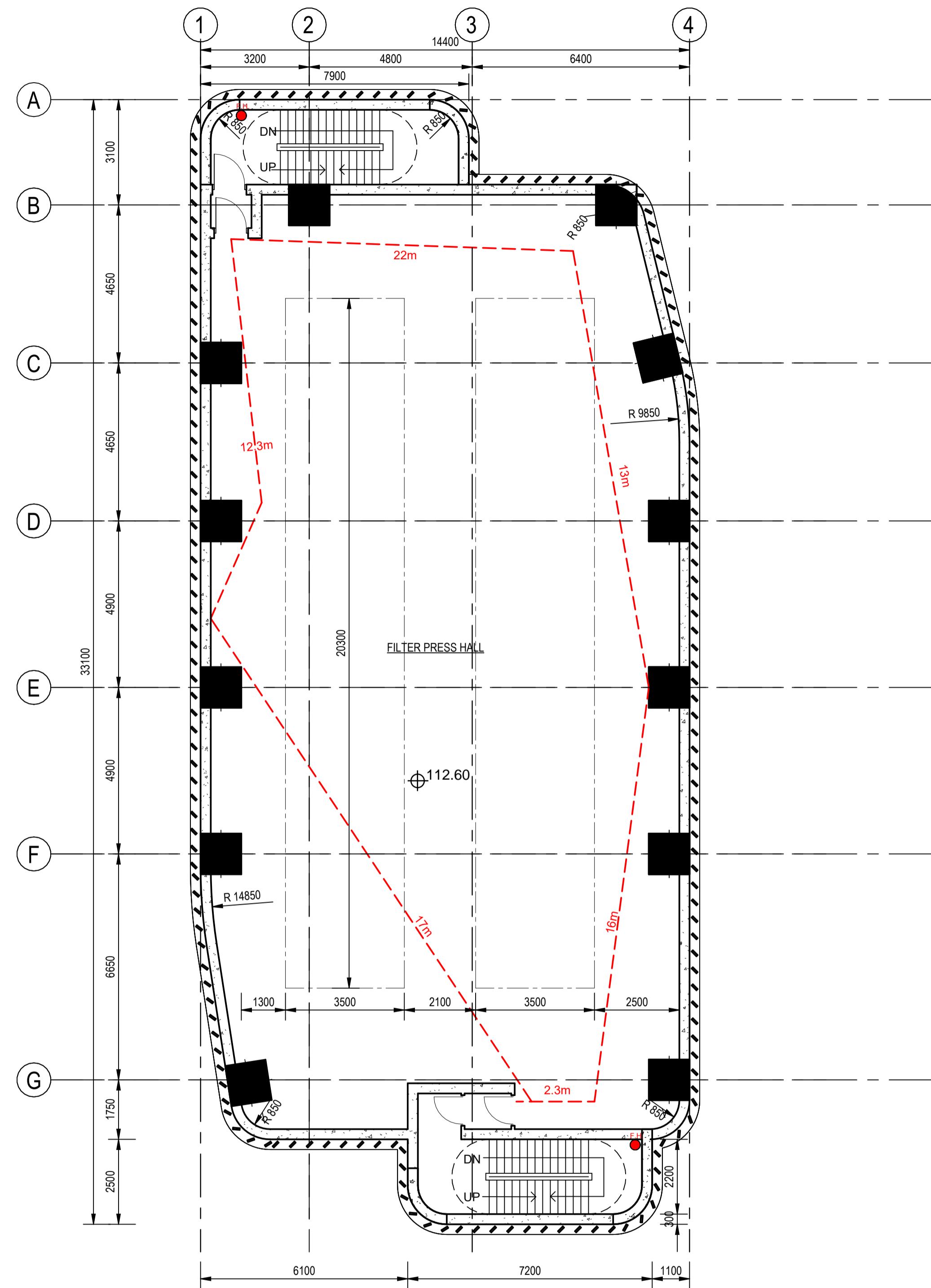

FIRST FLOOR
SCALE 1 : 100

Revision	Date	Description			Initial
		Designed	Checked	Drawn	
Initial	Designer	Checker	Author		

Approved

Agreement No. CE 82 / 2022 (WS)

Contract Title
IN - SITU REPROVISIONING OF TSUEN WAN WATER TREATMENT WORKS - INVESTIGATION, DESIGN AND CONSTRUCTION -

Drawing Title
GENERAL ARRANGEMENT - SLUDGE TREATMENT PLANT (PHASE 2) - FIRST FLOOR

Drawing No. **FIGURE 31** Revision

Scale A1 1 : 100

Client
 水務署
Water Supplies Department

Consultant
 **binnies**
BINNIES HONG KONG LIMITED
賓尼斯工程顧問有限公司

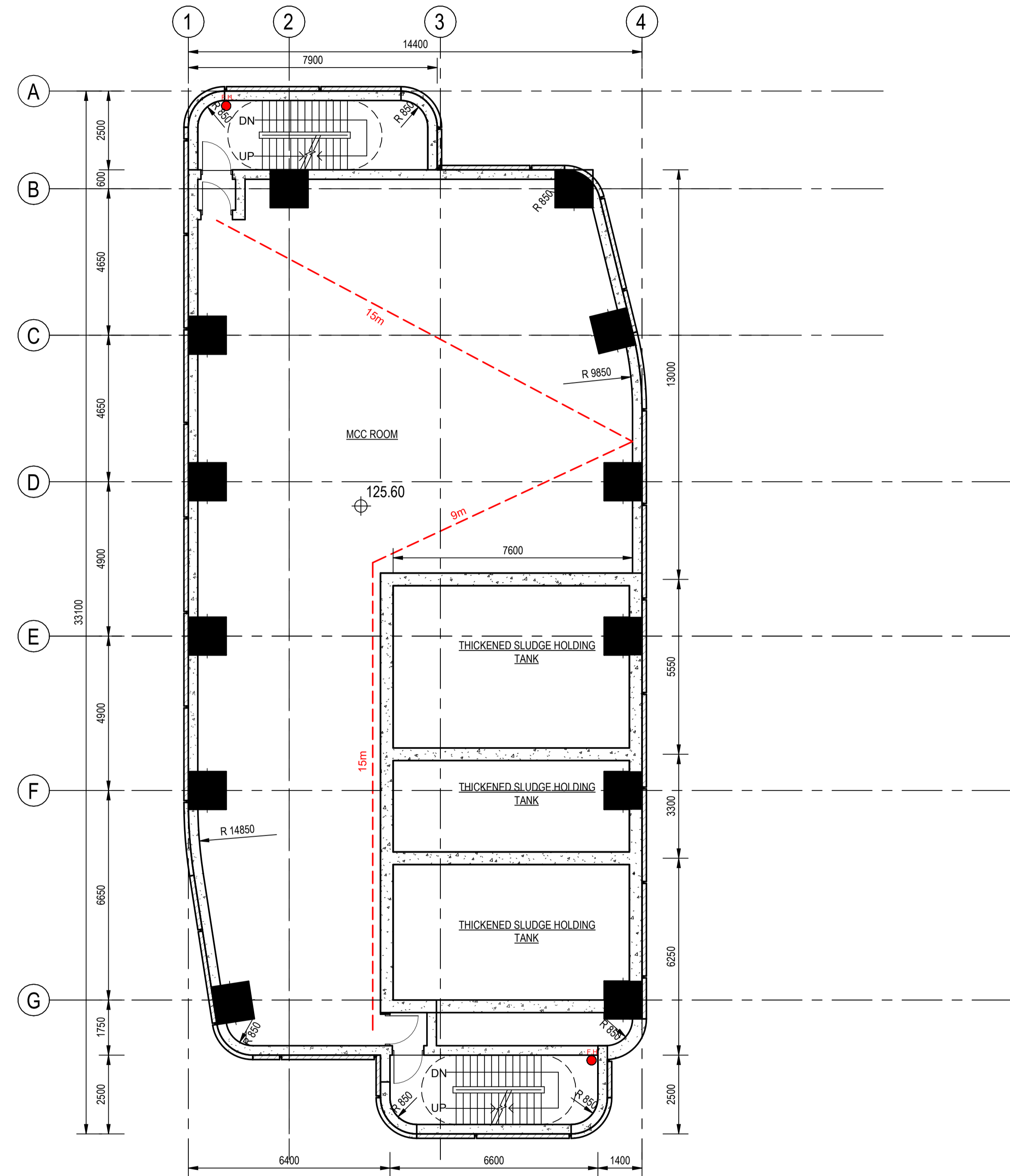

SECOND FLOOR
SCALE 1 : 100

Revision	Date	Description			Initial
		Designed	Checked	Drawn	Checked
		Designer	Checker	Author	
Date					
Approved					

Agreement No.
CE 82 / 2022 (WS)

Contract Title
IN - SITU REPROVISIONING OF TSUEN WAN WATER TREATMENT WORKS - INVESTIGATION, DESIGN AND CONSTRUCTION -

Drawing Title
GENERAL ARRANGEMENT - SLUDGE TREATMENT PLANT (PHASE 2) - SECOND FLOOR

Drawing No. FIGURE 32	Revision
--------------------------	----------

Scale
A1 1 : 100

Client

水務署
Water Supplies Department

Consultant

BINNIES HONG KONG LIMITED
賓尼斯工程顧問有限公司

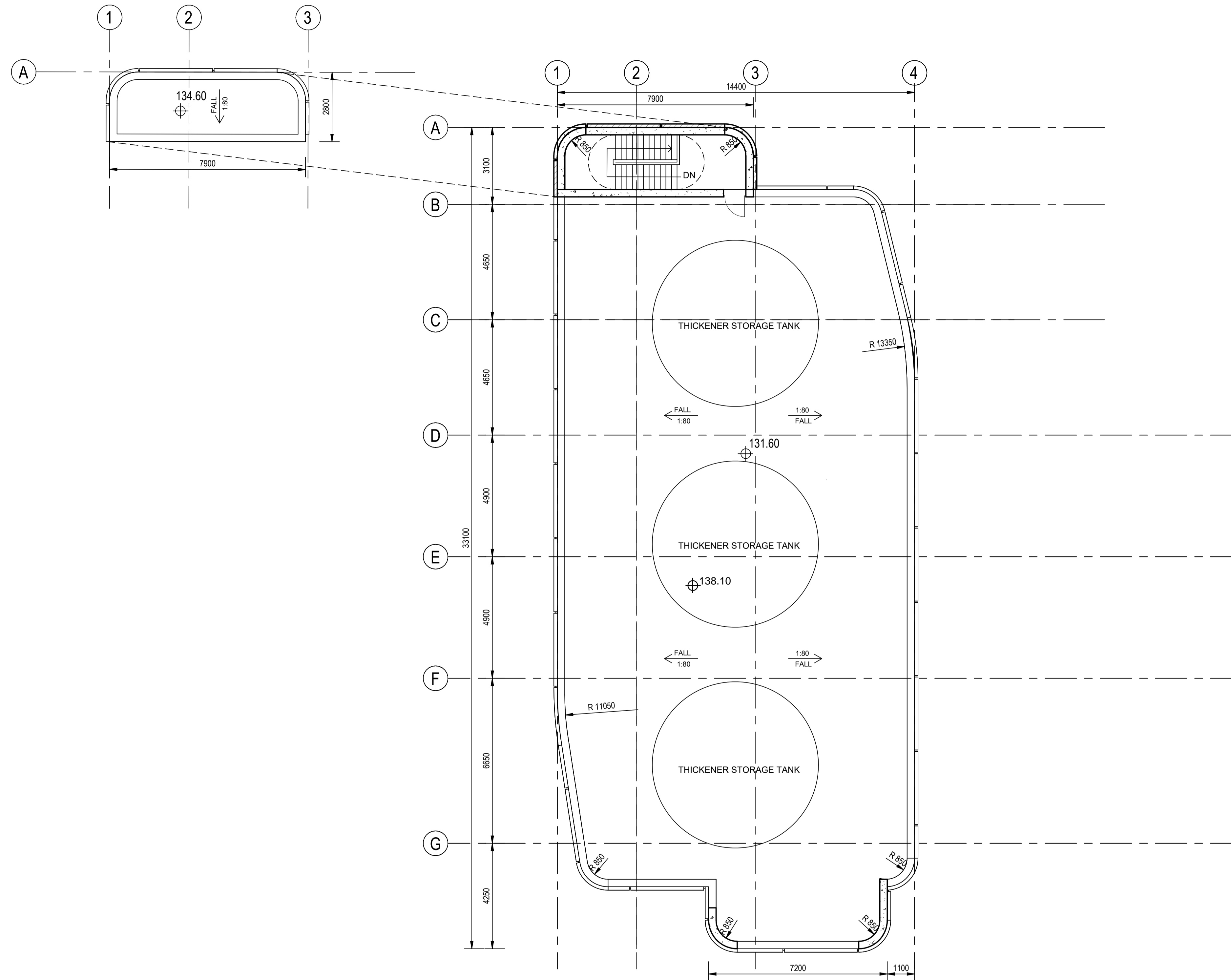

ROOF FLOOR
SCALE 1 : 100

Revision	Date	Description			Initial
		Designed	Checked	Drawn	
Initial	Designer	Checker	Author		
Date					

Approved

Agreement No.
CE 82 / 2022 (WS)

Contract Title
IN - SITU REPROVISIONING OF TSUEN WAN WATER TREATMENT WORKS - INVESTIGATION, DESIGN AND CONSTRUCTION -

Drawing Title
GENERAL ARRANGEMENT - SLUDGE TREATMENT PLANT (PHASE 2) - ROOF FLOOR

Drawing No. **FIGURE 33** Revision

Scale
A1 1 : 100

Client
 水務署
Water Supplies Department

Consultant
 BINNIES HONG KONG LIMITED
賓尼斯工程顧問有限公司

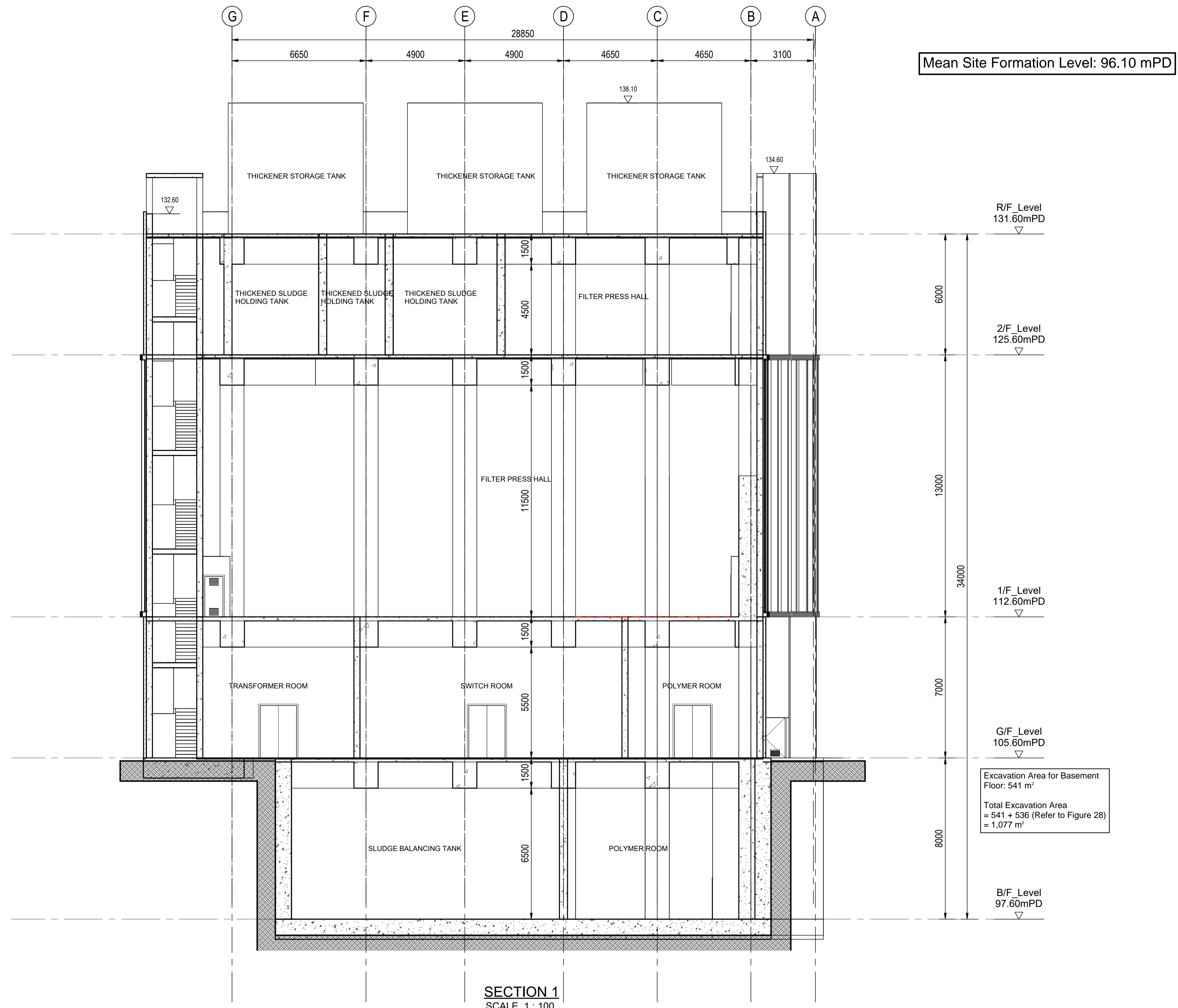

Revision	Date	Description			Initial
		Designed	Checked	Drawn	Checked
		Initial Designer	Checker	Author	

Approved

Agreement No. CE 82 / 2022 (WS)

Contract Title
IN - SITU REPROVISIONING OF TSUEN WAN WATER TREATMENT WORKS - INVESTIGATION, DESIGN AND CONSTRUCTION -

Drawing Title
GENERAL ARRANGEMENT - SLUDGE TREATMENT PLANT (PHASE 2) - SECTION 1

Drawing No. FIGURE 34

Scale A1 1:100

Client
 水務署
Water Supplies Department

Consultant
 BINNIES HONG KONG LIMITED
賓尼斯工程顧問有限公司

NOTES:

1. THE TREES AT CLOSE PROXIMITY TO THE APPLICATION SITE ARE SHOWN ONLY FOR CLARITY.

LEGEND:

- TREE TO BE REMOVED DUE TO UNDESIRABLE TREES

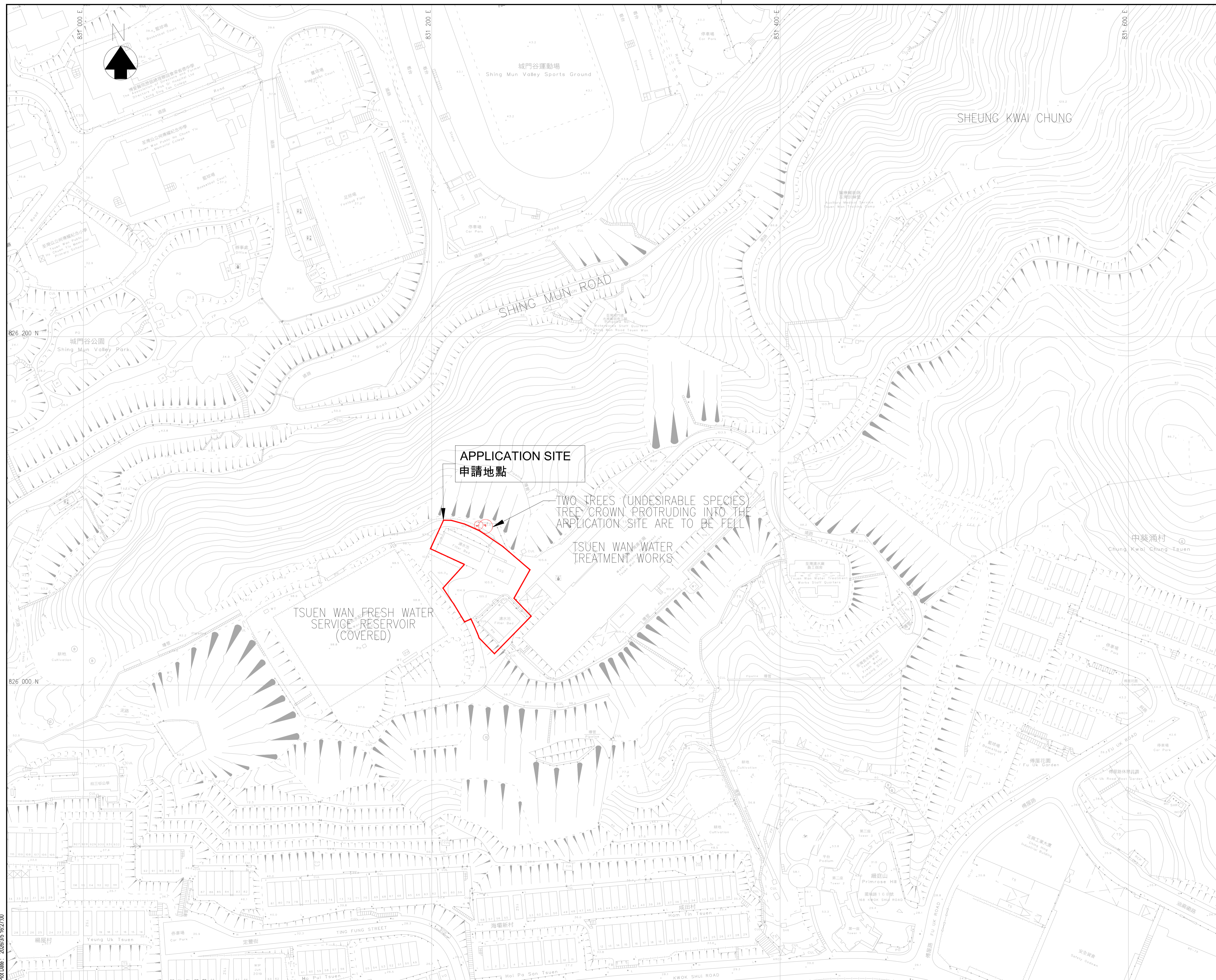

Revision	Date	Description			Initial
		Designed	Checked	Drawn	
Initial	-	-	-	SZ	LB
Date	08/25	08/25	08/25	08/25	08/25

Approved

Agreement No. CE 82/2022 (WS)

Contract Title
IN - SITU REPROVISIONING OF TSUEN WAN WATER TREATMENT WORKS - INVESTIGATION, DESIGN AND CONSTRUCTION

Drawing Title
TREE FELL LOCATION PLAN

Drawing No. FIGURE 35

Scale
A1 1 : 1000
A3 1 : 2000



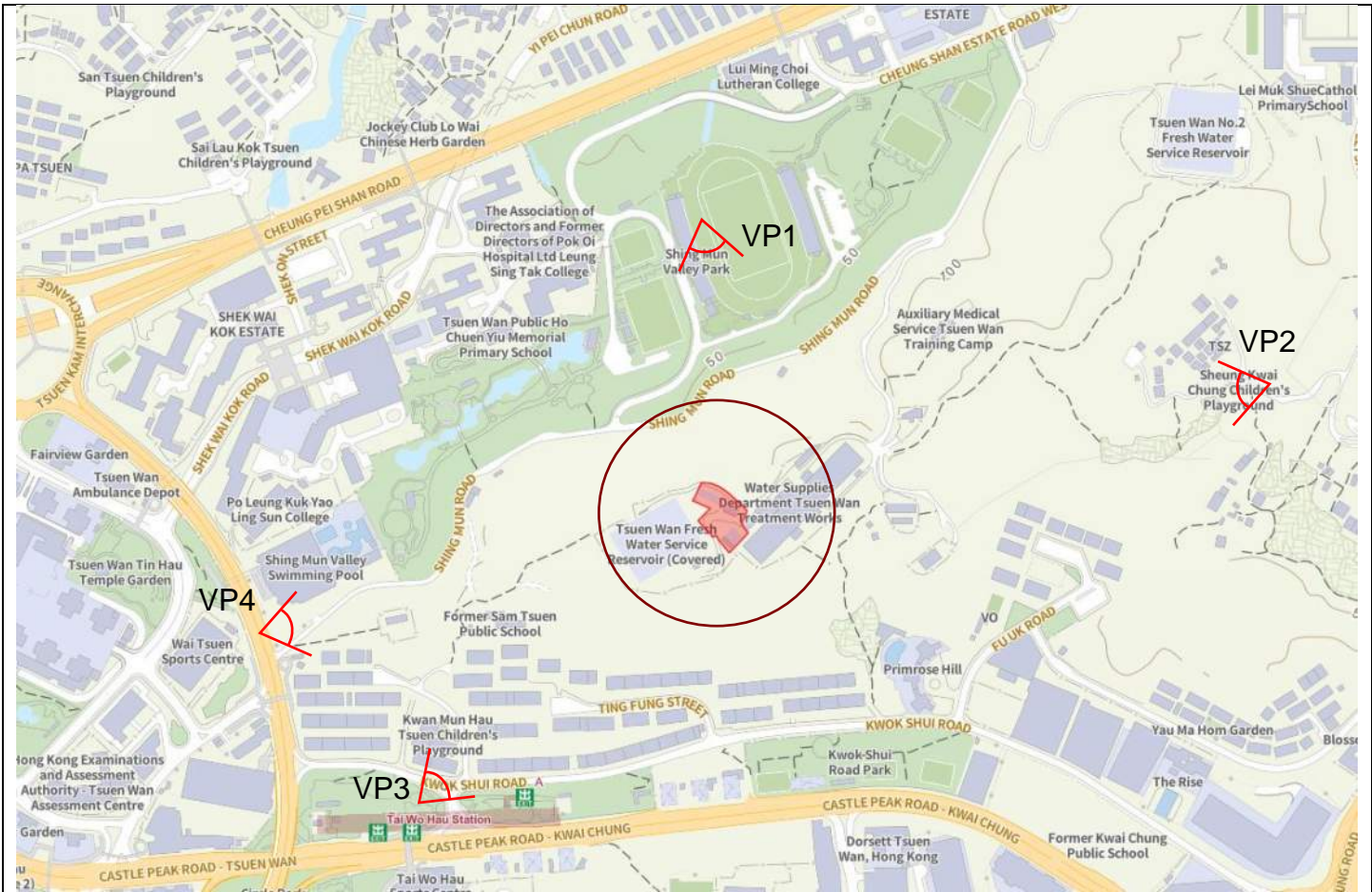

LEGEND

- Application Site
- Assessment Area Radius (3 x 40.5 m = 121.5 m)
- VP1: Shing Mun Valley Sports Ground
- VP2: Junction at Sheung Kwai Chung Children Play ground
- VP3: Kwok Shui Road Park
- VP4: Near the Entrance Gate at Shing Mun Valley Swimming Pool

Figure No.	Scale	Figure Title
36	-	Assessment Area and Location of Viewing Points
	Date March 2026	Source Geoinfo Map



Existing Condition

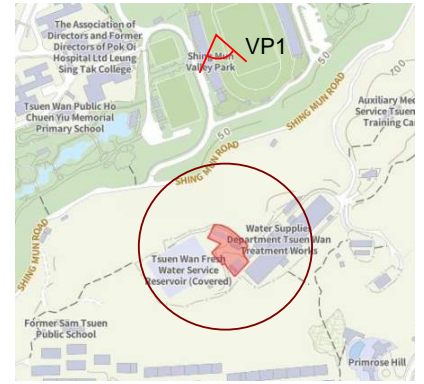

Key Plan



Proposed Development

Figure No.	Scale	Figure Title
37	-	Viewing Point 1 - Shing Mun Valley Sports Grounds
	Date March 2026	Source Photomontage for illustrative purpose



Existing Condition

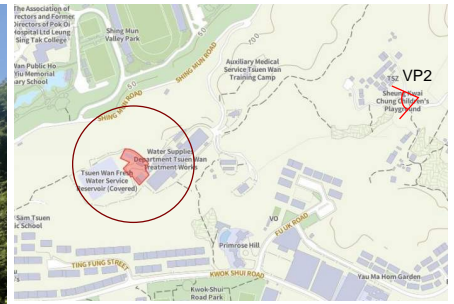

Key Plan



Proposed Development

Figure No.	Scale	Figure Title
38	-	Viewing Point 2 - Junction at Sheung Kwai Chung Children Playground
	Date March 2026	Source Photomontage for illustrative purpose



Existing Condition

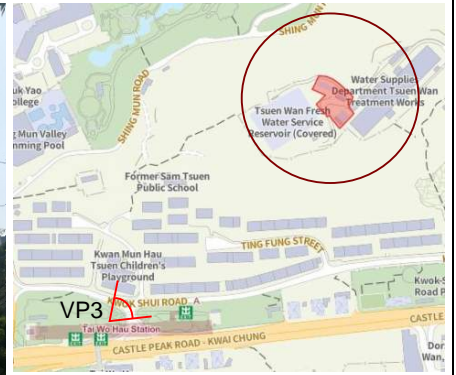

Key Plan



Proposed Development

Figure No.	Scale	Figure Title
39	-	Viewing Point 3 - Kwok Shui Road Park
	Date March 2026	Source Photomontage for illustrative purpose



Existing Condtion

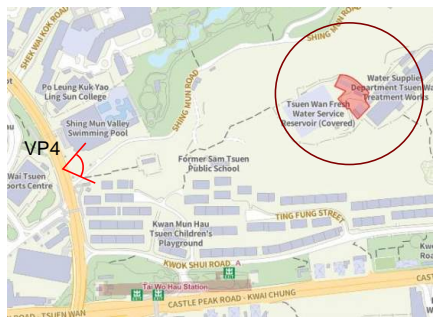

Key Plan



Proposed Development

Figure No.	Scale	Figure Title
40	-	Viewing Point 4 - Near the Entrance Gate at Shing Mun Valley Swimming Pool
	Date March 2026	Source Photomontage for illustrative purpose

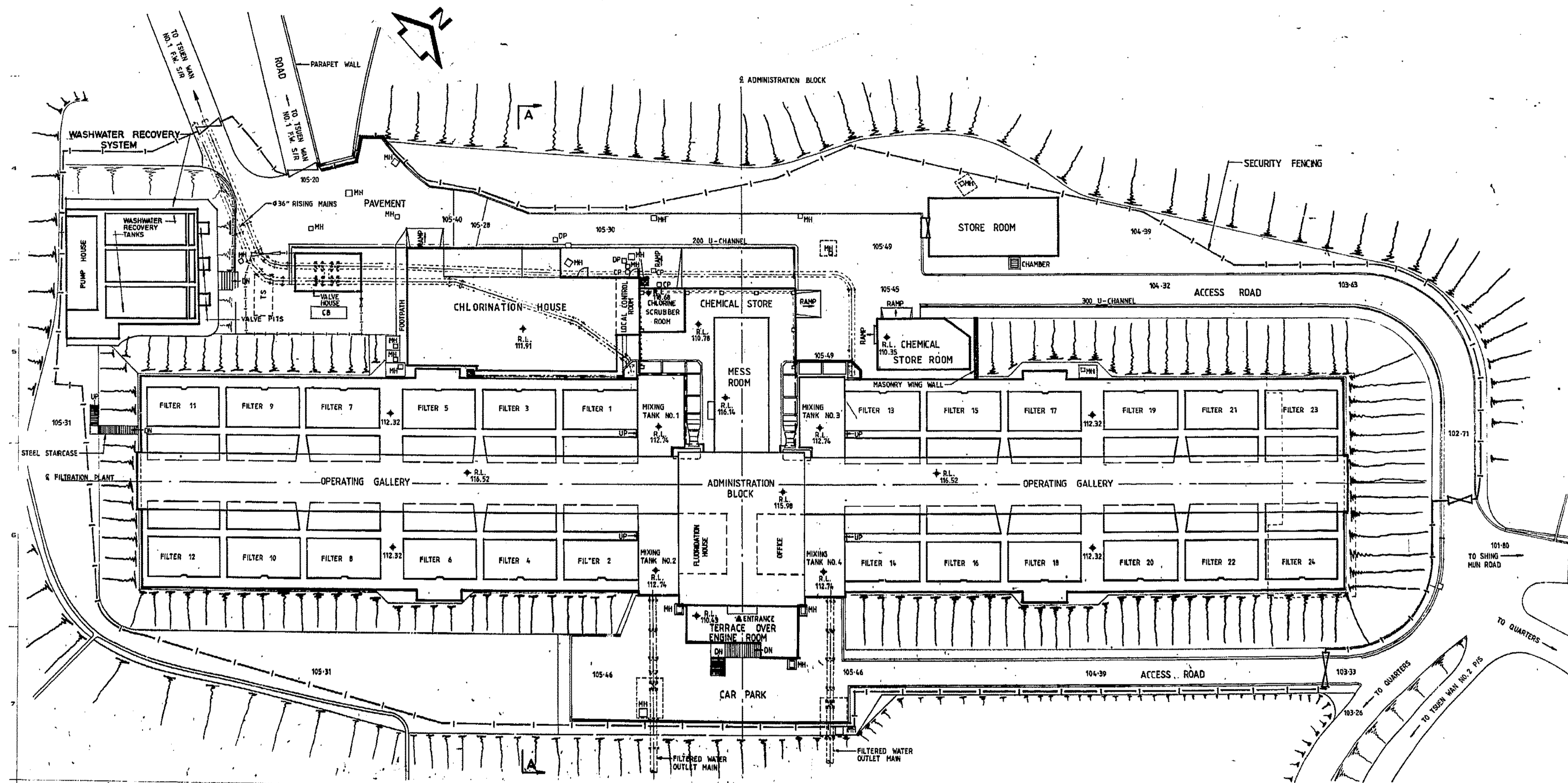

Revision	Date	Description	Initial

Agreement No. CE 82/2022 (WS)

Contract Title
IN - SITU REPROVISIONING OF TSUEN WAN WATER TREATMENT WORKS - INVESTIGATION, DESIGN AND CONSTRUCTION

Drawing Title
AS-BUILT DRAWING OF TSUEN WAN WATER TREATMENT WORKS

Drawing No. **FIGURE 41** Revision

